



AMC

CD & MP3

XCDise XCDise-vt

CD/MP3/USB/SD MULTI-MEDIA PLAYER

*24bit / 192KHz Sampling Advanced Segment DAC,
With AMC Proprietary Designed Switching Mode Power Supply to Cover 100 ~ 240VAC
For Using the Unit in All Countries in The World and
Give Superb Quality by High Regulated Power System Designs.*

- With RS232 for XCDise can be linked with AMC IoT IA System
- With Option of USB, Optical, Coaxial module with 24192 up-scaler for linking with computer systems and consumer products with Optical, Coaxial interface to give superb 24192 music quality for all type resolutions of digital input contents
- With USB, SD master interface connectors on front panel for users to play in USB & SD devices (slaves)

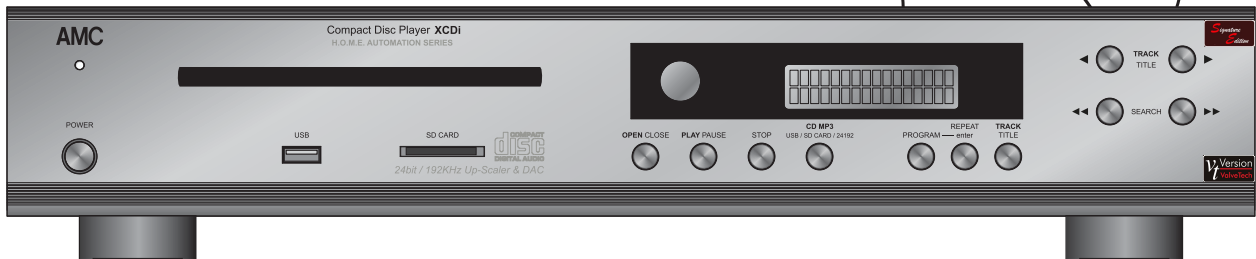
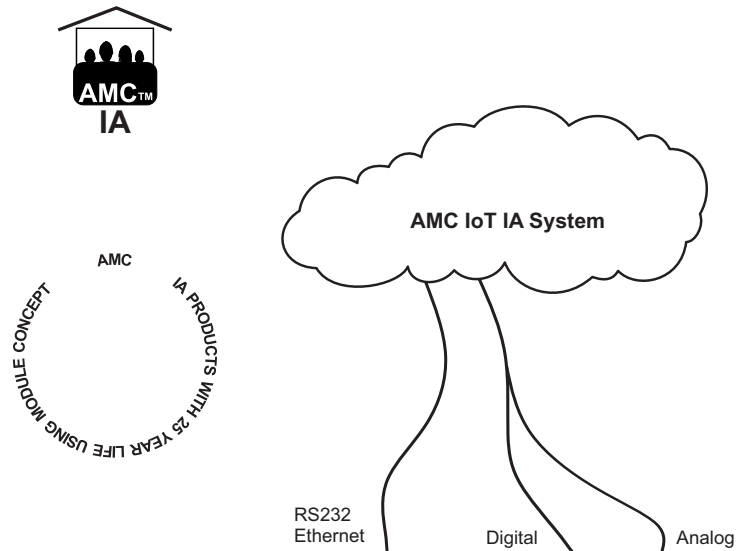

In the product and manual, AMC calls non-compressed PCM wave files Compact Disc as "CD", MP3 compressed music files as "MP3"

INSTRUCTIONS FOR INSTALLATION AND OPERATION



CAUTION: TO REDUCE THE RISK OF ELECTRIC SHOCK, DO NOT REMOVE COVER (OR BACK). NO USER-SERVICEABLE PARTS INSIDE. REFER SERVICING TO QUALIFIED SERVICE PERSONNEL



AFIN DEVIET UN CHOC ELECTRIQUE ET LES CONSEQUENCES GRAVES QUI POURRAIENT EN RESULTER, TENTEZ PAS D'OUVRIR L'APPAREIL ET DE TOUCHER AUX COMPOSANTS INTERNES SANS LA PRESENCE D'UNE PERSONNE QUALIFIEE.



PARA REDUCIR EL RIESGO DE SACUDIDAS ELECTRICAS, NO DEBERA QUITARSE LA TAPA (NI PARTE POSTERIOR). CONSULTESE AL PERSONAL CAPACITADO PARA LAS REPARACIONES INTERNAS.

WARNING: TO PREVENT FIRE OR ELECTRIC SHOCK, DO NOT EXPOSE THIS APPLIANCE TO RAIN OR MOISTURE.

ADVERTENCIA: PARA EVITAR EL RIESGO DE INCENDIO O SACUDIDA ELECTRICA, NO DEBERA EXPONERSE ESTE APARATO A LA LLUVIA O HUMEDAD.

CAUTION: TO PREVENT ELECTRIC SHOCK DO NOT USE THIS (POLARISED) PLUG WITH AN EXTENSION CORD, RECEPTACLE OR OTHER OUTLET UNLESS THE BLADES CAN BE FULLY INSERTED TO PREVENT BLADE EXPOSURE..

ATTENTION: POUR PREVENIR LES CHOCS ELECTRIQUES NE PAS UTILISER CETTE FICHE POLARISEE AVEC UN PROLONGATEUR. UNE PRISE DE COURANT OU UNE AUTRE SORTIE DE COURANT, SAUF SILES LAMES PEUVENT ETRE INSEREES A FOND SANS EN LAISSER AUCUNE PARTIE FOND SANS EN LAISSER AUCUNE PARTIE A DECOUVERT.

PRECAUCION: PARA EVITAR SACUDIDAS ELECTRICAS, NO DEBERA UTILIZARSE ESTA CLAVIJA POLARIZADA CON UN CORDON DE PROLONGACION, RECEPTACULO U OTRO TIPO DE SALIDA A MENOS QUE SE HAYAN INSERTASO COMPLETAMENTE LAS LENGÜETAS PARA EVITAR SU EXPOSICION.

NOTE: Some AMC products are equipped with dual or multi-voltage transformers (which is indicated on the back panel). If you wish to change the voltage, please bring your unit to an authorised AMC service technician for internal conversion.

ATTENTION: Quelques pièces AMC sont munies de transformateurs à double ou à multi-voltage (indiqué au panneau arrière). Si vous voulez changer le voltage, veuillez apporter votre appareil au fournisseur de AMC pour le transformer.

ZUR BEACHTUNG: Einige AMC Geräte sind mit Umschaltern für unterschiedliche Netzspannungern ausgerüstet (Ein Vermerk auf der Rückseite weist darauf hin).

Die Anpassung, wenn notwendig, muß von einem qualifizieren Techniker in einer AMC Servicestation vorgenommen werden.

NOTA: Ciertos componentes de AMC están dotados de transformadores de doble tensión o de varias tensiones (lo que se indica en el panel posterior). Si se desea cambiar la tensión, sírvanse llevar el aparato a un técnico autorizado por AMC para su conversión interna.

NOTE TO CATV systems installer: This reminder is provided to call the CATV system installer's attention to Article 820-22 of the NEC that provides guidelines for proper grounding and, in particular, specifies that the cable ground shall be connected to the grounding system of the building, as close to the point of cable entry as practical.

NOTA PARA EL INSTALADOR DE ANTENAS DE TELEVISION COLECTIVAS: La presente advertencia se provee para llamar la atención del instalador al Artículo 820-22 de NEC (Código Eléctrico Nacional) donde se facilitan las directrices para la pertinente puesta a tierra y que especifica en particular que el conductor a tierra del cable debe conectarse al sistema de conexión a tierra del edificio, lo más proximo posible al punto de entrada del cable.



The lightning flash with arrowhead, within an equilateral triangle, is intended to alert the user of the presence of "uninsulated" dangerous voltage" within the product's enclosure; that may be of sufficient magnitude to constitute a risk of electric shock to persons.



The exclamation point within an equilateral triangle is intended to alert the user of the presence of important operating and maintenance (servicing) instructions in the literature accompanying the appliance.

CAUTION

WARNING! INVISIBLE LASER RADIATION WHEN OPEN AND INTERLOCKS DEFEATED. AVOID EXPOSURE TO BEAM.

VORSICHT! UNSICHTBARE LASERSTRAHLEN TRITTAUS. WENN DECKEL GEÖFFNET UND WENN SICHERHEITSVERRIEGELUNG ÜBERBRÜCKT IST, NICHT DEM STRAHL AUSSETZEN.

ADVARSEL- USYNLIG LASERSTRÅLING VED ÅBNING, NÅR SIKKERHEDSAFBRYDERE ER UDE AF FUNKTION. UNDGÅ UDSÆTTELSE FOR STRÅLING.

ADVARSEL- USYNLIG LASERSTRÅLING NÅR DEKSEL ÅPNES OG SIKKERHEDSLÅS BRYTES. UNNGÅ EKSPONERING FOR STRÅLEN.

VARNING- OSYNLIG LASERSTRÅLING NÅR DENNA DEL ÄR ÖPPNAD OCH SPÄRRAR ÄR URKOPPLADE. STRÅLEN ÄR FARLIG.

VARO! AVATTAESSA JA SUOJALUKITUS OHITETTAESSA OLET ALTTIINA NÄKYMÄTÖNNÄ LASERISÄTEILYLLE. ÄLÄ KÄÄTÖSÄTEESEEN.

SERVICE SAFETY PRECAUTIONS (UL)

1. Use exact replacement parts for critical locations, marked "△".
2. Return lead dress to original position, and re install protective covers.
3. Before returning to customer, test for shock hazard; use either method A or B:
 - A. Leakage test, "cold":
 1. Unplug AC cord; turn power switch ON.
 2. Connect one lead of High Voltage Insulation Tester to both prongs of AC plug.
 3. Touch other lead to all exposed metal parts.
 4. Impedance measurement must be 0.3-5.0 Megohms.
 - B. Leakage test, "live":
 1. Plug unit directly into AC outlet; do not use isolation transformer.
 2. Connect one lead of Leakage Current Tester to earth ground.
 3. Touch other lead to all exposed metal parts.
 4. Leakage measurement must be less than 0.5 milliamps.

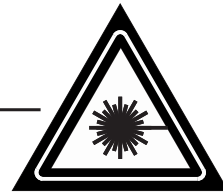
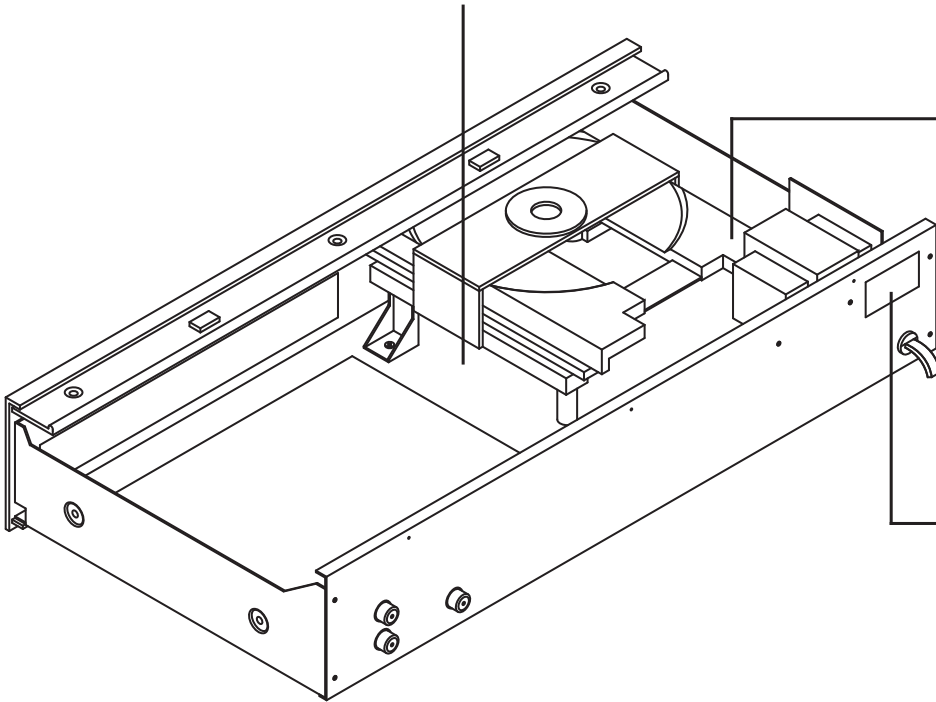

CLASS 1 LASER PRODUCT
LUOKAN 1 LASERPLAITE
KLASS 1 LASERAPPARAT

CAUTION: FOR CONTINUED PROTECTION AGAINST RISK OF FIRE, REPLACE ONLY WITH THE SAME TYPE OF T1A/250V FUSES.

ATTENTION: POUR MAINTENIR PROTECTION CONTRE RISQUE D'INCENDIE, UTILISER LES FUSIBLES DE RECHANGE DE MEME TYPE DE T1A/250V.

THIS DIGITAL APPARATUS DOES NOT EXCEED THE CLASS B LIMITS FOR RADIO NOISE EMISSIONS FROM DIGITAL APPARATUS AS SET OUT IN THE RADIO INTERFERENCE REGULATIONS OF THE CANADIAN DEPARTMENT OF COMMUNICATIONS.

LE PRESENT APPAREIL NUMERIQUE N'EMET PAS DE BRUITS RADIOELECTRIQUES DEPASSANT LES LIMITES APPLICABLES AUX APPAREILS NUMERIQUE DE LA CLASSE B PRESCRITES DANS LE REGLEMENT SUR LE BROUILLAGE RADIO ELECTRIQUE EDICTE PAR LE MINISTERE DES COMMUNICATIONS DU CANADA.

THIS DEVICE COMPLIES WITH PART 15 OF THE FCC RULES. OPERATION IS SUBJECT TO THE FOLLOWING TWO CONDITIONS:

- (1) THIS DEVICE MAY NOT CAUSE HARMFUL INTERFERENCE, AND
- (2) THIS DEVICE MUST ACCEPT ANY INTERFERENCE RECEIVED, INCLUDING INTERFERENCE THAT MAY CAUSE UNDESIRE OPERATION.

APPLICATION AND FEATURE LIST

FEATURES OF THE AMC™ MODEL XCDise for CD MP3 USB SD

- The AMC model XCDise was designed to play standard **non-compressed PCM Compact Disc** (hereafter we will call it "**CD**") , **MP3 compressed Compact Disc** (hereafter we will call it "**MP3**"), USB, SD
- With RS232 for XCDise can be linked with AMC IoT IA System.
- With Option of USB, Optical, Coaxial module with 24192 up-scaler for linking with computer systems and consumer products with Optical, Coaxial interface to give superb 24192 music quality for all type resolutions of digital input contents.
- With USB, SD master interface connectors on front panel for users to play in USB & SD devices (slaves)
- The AMC model XCDise was designed to meet professional quality performance standard and to provide superior value.
- Selected grade components are utilized throughout the circuit design with special emphasis on components within the audio path to assure stable, consistent performance.
- Premium transport and servo drive system assures constant data retrieval and unsurpassed tracking performance,
- Use Burr Brown from TI **PCM1798, 24-Bit/ 192 KHz Sampling Advanced Segment D/A Converter architecture** to achieve **excellent dynamic performance (123dB typically)** and improved tolerance to clock jitter. The DAC offers excellent **SNR up to 123dB typical**, excellent **THD+N down to 0.0005% typical** and with excellent **8x Over-sampling** Digital Filter giving **Pass-Band Ripple down to + - 0.002dB**. The DAC can handle **sampling frequency of 10kHz to 200kHz** and **accepts 16-, 20- and 24-Bit Audio Data** and it installed with **Digital De-Emphasis**.
- Unique 5-pole linear active LPF (Low Pass Filter) prevents interference from ultrasonic noise commonly found in other CD playback systems.
- Advanced switching mode power supply design incorporates separate windings for the digital, analog and servo circuits to prevent interference and preserve sonic performance.
- EIA calibrated audio outputs ensure proper match with pre-amplifiers and receivers.
- Up to 20 tracks may be programmed to playback in desire order.
- Full-function infrared (IR) remote control with direct track access.
- With AMC proprietary designed switching mode power supply to cover 100 ~ 240VAC for using the unit in all countries in the world and give superb sound quality by high regulated power system designs.

About XCDise-vt:

- XCDise-vt is a special designed XCDise with vacuum tubes for offering superb sound quality for Hi-Fi fans, golden ears and vacuum tube gears.
- XCDise-vt incorporates an independent high voltage power supplies for the valve circuitries.
- The valves in XCDise-vt are working in a so-called "class A" amplification that claims the best sound reproduction.
- XCDise can be upgraded to XCDise-vt by installing MD5404 into XCDise. Please refer to Appendix 3 for the reinstalling procedures.

REAR PANEL CONNECTIONS/FRONT PANEL CONTROLS

REAR PANEL

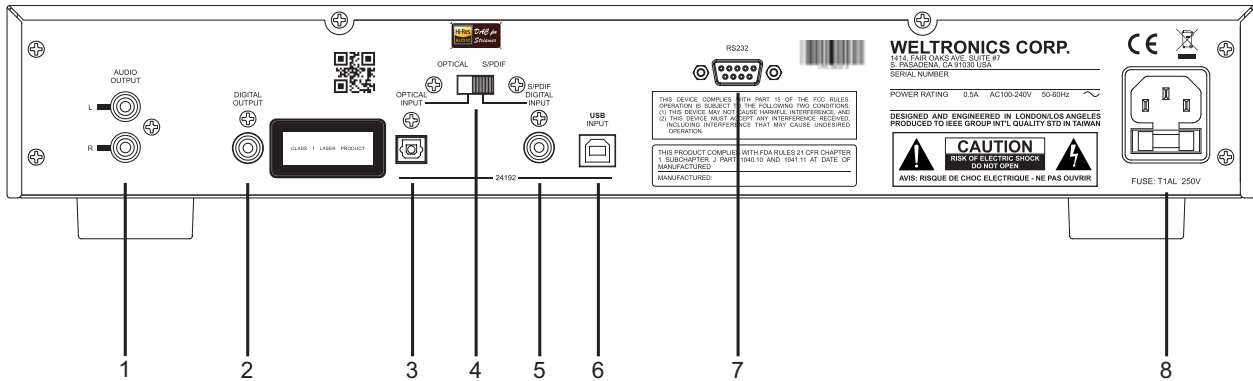

- | | |
|--------------------------------------|----------------------------------|
| 1. AUDIO OUTPUT | 5. S/PDIF DIGITAL INPUT (OPTION) |
| 2. DIGITAL OUTPUT | 6. USB (OPTION) |
| 3. OPTICAL (OPTION) | 7. RS232 INTERFACE CONNECTOR |
| 4. SWITCH - OPTICAL, S/PDIF (OPTION) | 8. RECEPTACLE & FUSE (T1AL 250V) |

FRONT PANEL

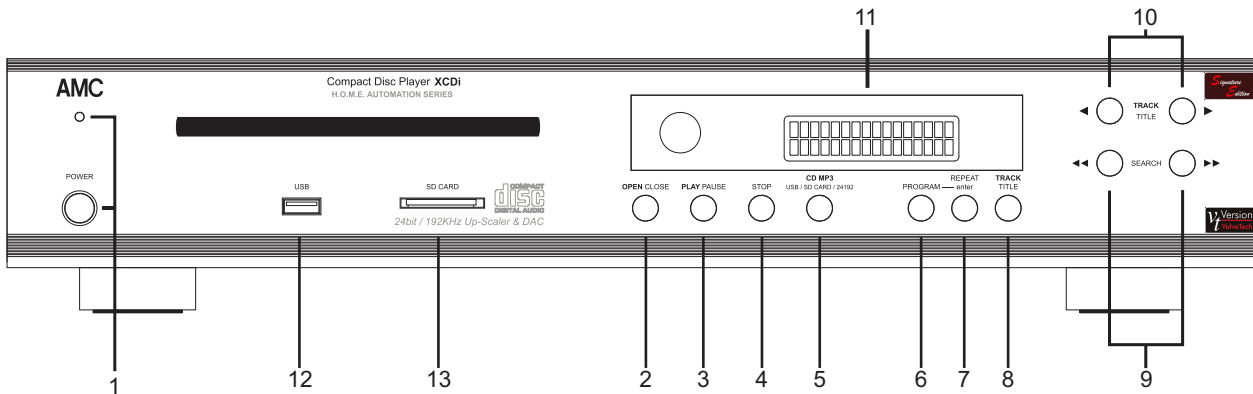

- | | |
|-------------------------------------|---------------------------|
| 1. POWER SWITCH AND POWER INDICATOR | 7. REPEAT / PROGRAM enter |
| 2. OPEN/CLOSE | 8. TRACK / TITLE |
| 3. PLAY/PAUSE | 9. ◀ SEARCH ▶ |
| 4. STOP | 10. ◀◀ TRACK / TITLE ▶▶ |
| 5. CD / USB / SD CARD / 24192 | 11. DISPLAY |
| 6. PROGRAM | 12. USB |
| | 13. SD CARD |

REAR PANEL CONNECTIONS

1. AUDIO OUTPUT

Connect the left and right channel unbalanced (RCA) audio outputs to any input on your pre-amplifier or receiver **except** "Phono" or "Turntable". High-quality interconnection cables are recommended.

2. DIGITAL OUTPUT

Co-axial cable digital output. (For some units, they are only made provision for future upgrade, please contact your dealer or distributor if you have problem).

3. OPTICAL INPUT (OPTION - Including optional firmware & hardware)

Once MD5501 or MD5502 module is installed in XCDise, you will be able to connect optical output of your DVD player to the input in order to enjoy high sound quality by using the up-sampling feature of MD5501 or MD5502 to upscale the digital signal to 24bit/192KHz and then use one of the AMC proprietary designed highest quality 24bit/192KHz DAC installed in XCDise to make it possible for you to enjoy highest possible sound quality from your DVD player with superb with superb sound stage and bandwidth.

4. SWITCH - OPTICAL, S/PDIF (OPTION)

Once MD5501 or MD5502 module is installed in XCDise, there will be a switch to switch digital inputs between "OPTICAL INPUT" and "S/PDIF DIGITAL INPUT"

5. S/PDIF DIGITAL INPUT (OPTION)

Once MD5501 or MD5502 module is installed in XCDise, the "SWITCH -OPTICAL, S/PDIF" can select digital input between "OPTICAL INPUT" and "S/PDIF DIGITAL INPUT"

6. USB (Computer, Gamer) (OPTION)

Once MD5501 or MD5502 module is installed in XCDise, you will be able to connect USB of your computer or Game Console to the USB connector in order to enjoy high sound quality by using the up-scaling feature of MD5501 or MD5502 to up-scale the digital signal to 24bit/192KHz and then use one of the AMC proprietary designed highest quality DAC installed in XCDise to make it possible for you to enjoy highest possible sound quality from your computer or game console with superb sound stage and bandwidth.

7. RS232

With RS232 and Digital & Analog outputs, XCDise can be linked with AMC or any other IoT IA systems for IoT IA systems to control XCDise or get contents/status from XCDise.

For details of RS232 commands, please refer to the APPENDIX 5.

Control XCDise through RS232 using computer, please refer to APPENDIX 6.

8. AC RECEPTACLE

The AC RECEPTACLE is for you to plug in with power cord attached in the packing or you can plug in with other power cord with your preferences.

FRONT PANEL CONTROLS

1. POWER SWITCH

Depressing the power switch turns on the CD player. The blue LED indicator above the power switch will glow blue.

Note: The unit is with switching power supply for AC 100V to 240V globally.

2. OPEN / CLOSE

When there is CD inside the unit, by pressing the OPEN/CLOSE button the CD disc will be ejected out of the CD slot. While a disc is playing and OPEN/CLOSE is pressed, the disc will keep playing. OPEN/CLOSE button will only work during PAUSE or STOP mode. If the OPEN/CLOSE button is pushed after programming the player, all programming will be erased.

When you load in CD, it will take around 5 sec to load all information from disc to the memory of XCDisc. Once all data are loaded, the display will show number of tracks and total time on the disc (abc de:fg:hi; abc=number of tracks, de=hours, fg=minutes, hi=sec) for around 2 sec, then display track #1 and 00:00:00, and get into pause mode after around 1 sec, you can push "STOP" button to display numbers of tracks and total time on the disc.

For MP3, when you press OPEN/ CLOSE button to close disc drawer, the window will display "CLOSE" for around one second then display "READING" and it will take around 5 sec to load all

information from disc to the memory of XCDisc. Once all data are loaded, the display will show numbers of tracks inside the disc.

3. PLAY/PAUSE

Place CD or MP3 discs into the opened drawer with the label facing up. Press the PLAY/PAUSE button or OPEN/CLOSE button will both close the drawer and pass through the procedure described on above item "2.OPEN/CLOSE". When all data are loaded, you can press PLAY/PAUSE button and begin playback. Or you can use TRACK or TITLE Up/ Down buttons (10) to go to the TRACK you selected and then press PLAY/PAUSE button and begin playback. For CD, you will only be able to select TRACK as there is no TITLE defined in CD.

Playback will stop when STOP button is pressed or when the disc has reached the end. While the disc is playing, press the PLAY/PAUSE button to suspend playback (PAUSE). Press the PLAY/PAUSE button again to resume playback.

4. STOP

To stop the CD or MP3 while playing, press the STOP button. Pressing the STOP button will cancel any repeat-play cycles and the display will show the numbers of the tracks and total time on the disc. (CD only)

STOP button will also clear PROGRAM and RANDOM play.

5. CD MP3 / USB / SD CARD / 24192 (SOURCE)

XCDisc can play CD & MP3 Discs or USB or SD Card.

The default position is on "CD MP3". Under "CD MP3" position, you can play CD or MP3 discs from the disc drawer of the XCDisc unit. By pressing the button the input will be switched to USB or SD CARD.

6. PROGRAM

The XCDise can be programmed to play up to 20 tracks in any desired order.

Press the PROGRAM button you can start to program playback. The "P-01" indicator will be turned on and ready for programming.

- a) Use TRACK or TITLE Up/ Down buttons (10) to go to the TRACK you will like to put into the PROGRAM.
- b) Press "PROGRAM" button to put the TRACK # into the PROGRAM.
- c) The number (:##) after "P-" indicates number of PROGRAM you are putting in. So, once you press "PROGRAM" button the number will increase 1.
- d) Repeat above step "a)" and "b)" until all TRACKS you like to put into PROGRAM are entered.
- e) Press PLAY/PAUSE button to start the playback following the sequence you entered into the PROGRAM.
- f) To clear the PROGRAM memory, press STOP button.

7. REPEAT / enter

This REPEAT button will allow three different types of endless play modes.

Press REPEAT button once, the word "1" will appear on the display and the selected track will be repeated endlessly until the STOP button is pressed.

Press REPEAT button a second time, the word "A" will appear and all tracks will be repeated endlessly until the STOP button is pressed.

Press REPEAT button a 3rd time to cancel REPEAT mode. The display and operation will return to normal.

8. TRACK / TITLE

This is button to select TRACK or TITLE of MP3 disc or USB or SD Card. For CD disc, this button has no function.

The default is TRACK mode. The display inside window will only show the TRACK number (###). Under TRACK mode, you can change TRACK # Up or Down by pressing the TRACK/TITLE Up (>) or Down (<) button.

When you press the button once, it will switch from TRACK mode to TITLE mode and the staying 5 sec. for TITLE select, You can change TITLE # Up or Down by pressing the TRACK/ TITLE Up (>) or Down (<) button. The English title name will show in display.

Press the button again to confirm your selection.

9. ◀ SEARCH ▶

Press and hold SEARCH (<< or >>) to find a desired starting point or a certain part of a track.

10. ◀ TRACK / TITLE ▶

Press TRACK / TITLE (< or >) to find a desired TRACK or TITLE corresponding to what the mode TRACK/ TITLE button selected.

11. DISPLAY

When loading a disc and using the OPEN/CLOSE button to close the disc drawer, the TOC (Table of Contents) of the disc will be read and display will show the number of tracks and total playing time of all the tracks on the disc. For those discs without TOC or data of time of each track, the display of total time on the disc will be "00:00" (For discs you generated yourself from your computer will be the case.)

During playing, the following information is displayed:

by the control buttons on front panel or remote handset.

TRACK Number

These track numbers are identified on the CD/MP3/USB/SD Card package and are encoded in the disc by the disc manufacturer.

XCDise has been tested with USB sticker/SD card devices up to 16GB with FAT16, FAT32 format.

Time

Shows in minutes and seconds the time elapsed in the music since the beginning of the current track.

>

Glows to indicate disc is playing.

||

Glows to indicate the playing of disc is under PAUSE mode.

1

Glows during repeat play of a single track.

A

Glows during repeat play of the entire disc.

P-01

Glows during PROGRAM play.

RDM

Glows during RANDOM play.

12. USB Socket

Insert an USB stick containing MP3 music files for playback.

You can play/select USB stick music files by the control buttons on front panel or remote handset.

13. SD Card Slot

Insert SD card containing MP3 music files for playback.

You can play/select SD card music files

REMOTE CONTROL

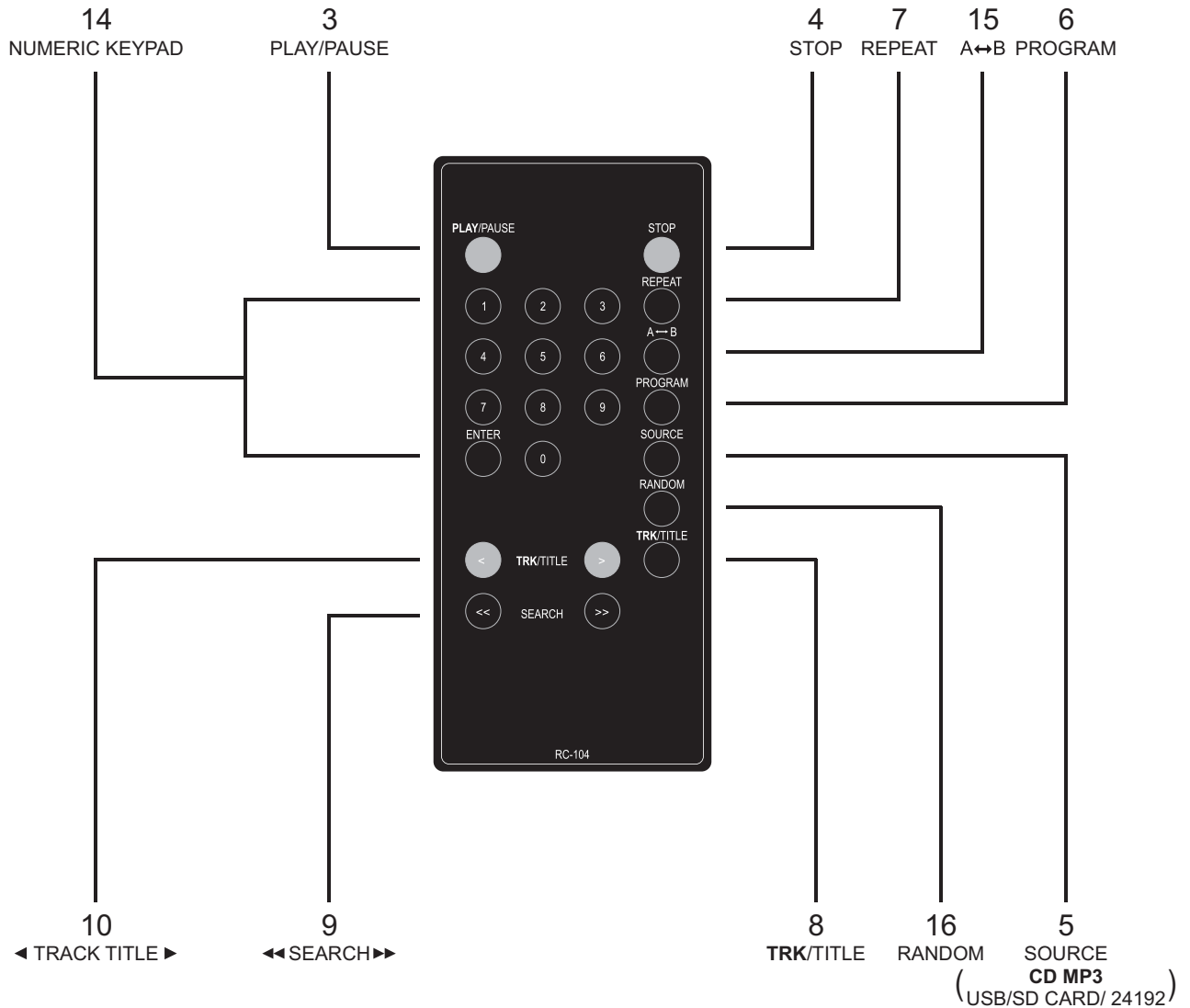

REMOTE CONTROL

An infrared (IR) remote control is provided for convenience operation of the XCDise. The handset provides the same control functions as the front panel PLUS three additional control functions.

14. NUMERIC KEYPAD (0-9,ENTER)

Allows direct selection of desired track. Upon entry of the desired track number, the player shifts to the beginning of the track and begins to play. Press required TRACK numbers and press ENTER to complete the entry of the track number.

16. RANDOM

Pressing RANDOM will play all the tracks on the CD in a random order. Press STOP button or RANDOM button again will cancel RANDOM play.

15. A↔B

This button engages a repeat cycle between any two locations on the disc (point A to point B)

SPECIFICATIONS

AUDIO OUTPUT (Ref. 1KHz/0dB, unless otherwise stated):

Disc capacity.....	Single disc, 120 or 80mm
Digital to analogue conversion	Burr-Brown Advanced segment DAC architecture
Digital filter.....	8X over-sampling at up to 24-Bit/192KHz sampling rate (Stop band attenuation:-98dB, pass-band ripple: +/-0.002dB)
Analogue filter.....	5-Pole active
Frequency response 5Hz-20KHz.....	<+/-0.2 dB
De-Emphasis error.....	<+/-0.2 dB
Linearity.....	+/-0.5 dB; 0 to -100 dB
Channel separation (20Hz to 20KHz).....	>100 dB
Channel imbalance.....	<+/-0.1 dB
S/N ratio (A-weighted, measured with all zeros test disc).....	115 dB
Dynamic range.....	102 dB
THD (at 0dB, 1KHz, A-weighted).....	0.0011%
Inter-modulation distortion (19 & 20 KHz).....	<-110 dB
Output impedance.....	120 ohm
Output level at 0dB.....	2.2 Vrms
Digital error correction.....	CIRC with double error correction in C1 and C2
Wow and flutter.....	Immeasurable (Quartz crystal accuracy)
Remote control unit.....	Full functional with numeric keypad

S/PDIF DIGITAL OUTPUT:

Digital output level.....	0.5 Vpp
Load impedance.....	75 ohm
Peak emission wave length.....	660 nm

PHYSICAL

Dimensions (W x H x D).....	430x82x300 mm
Net weight.....	4.0 Kgs
Shipping weight (4 pieces).....	22.5 Kgs
Power consumption.....	30 W
AC voltage.....	100V ~ 240V

Weltronics Corp. reserved the right to improve its products at any time. Specifications are subject to change without notice.

APPENDIX 1: MP3 Audio Format

MP3 Audio Format:

File: MPEG1, 2, 2.5 layer3

File extension: [.MP3]

Folder name, file name length: 64 bytes (max)

ID3 TAG: Version2.4, Version2.3, Version2.2, Version1.1, Version1.0

ID3 title/artist/album, the max number of bytes of title/artist/album is 60/60/60

Sampling rate (KHz): 48, 44.1, 32, 24, 22.05, 16

Bit rate (Kbps): 320, 256, 224, 192, 160, 144, 128, 112, 96, 80, 64, 56, 48, 40, 32 / Variable bit-rate

APPENDIX 2:

AMC CD Player Remote Code List

Customer Code: 07FC

RC103 = RC-0039*B	Hex	D0	D1	D2	D3	D4	D5	D6	D7
Random	00	0	0	0	0	0	0	0	0
Repeat	01	1	0	0	0	0	0	0	0
Trk/Title	02	0	1	0	0	0	0	0	0
Program	03	1	1	0	0	0	0	0	0
A<->B	06	0	1	1	0	0	0	0	0
Enter	07	1	1	1	0	0	0	0	0
#0	08	0	0	0	1	0	0	0	0
#1	09	1	0	0	1	0	0	0	0
Search Dn <<	0A	0	1	0	1	0	0	0	0
#4	0D	1	0	1	1	0	0	0	0
Trk/Title Dn <<	0E	0	1	1	1	0	0	0	0
Stop	0F	1	1	1	1	0	0	0	0
#7	11	1	0	0	0	1	0	0	0
Play/Pause	14	0	0	1	0	1	0	0	0
#8	15	1	0	1	0	1	0	0	0
#9	17	1	1	1	0	1	0	0	0
CD MP3 24192	18	0	0	0	1	1	0	0	0
#5	19	1	0	0	1	1	0	0	0
Trk/Title Up >>	1A	0	1	0	1	1	0	0	0
#6	1B	1	1	0	1	1	0	0	0
#2	1D	1	0	1	1	1	0	0	0
Search Up >>	1E	0	1	1	1	1	0	0	0
#3	1F	1	1	1	1	1	0	0	0



APPENDIX 3: Installing MD5404 into XCDIS

1. MD5404 package

1.1 Vacuum Tube Module MD5404



1.2 Parts

1.2.1 PCB Spacer x 6

1.2.2 Screw Tapping T3x6SL (Black) x 2

1.2.3 Label vt, Black x 1 & Silver x 1

1.2.4 Cable Tie x 6



2. Install MD5404 into position
- 2.1 Insert PCB spacer x 5 pcs to bottom chassis
- 2.2 Screw 2 black screws to transformer bracket

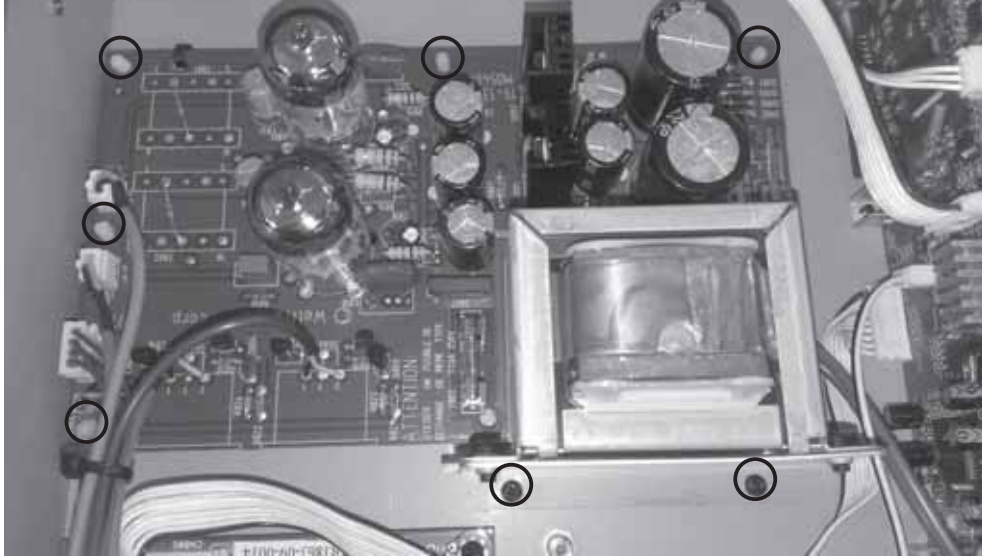

3. Connect MAINS (P4 & P5 Power Supply Board)



4. Insert the ground lug between PCB copper tracks and stud then screw tightly.



5. Insert connectors to DAC board

- 5.1 4P BLUE wire – CN803 to DAC CN810
- 5.2 Soldered SK801 BLUE wire to DAC CN808
- 5.3 Soldered SK802 BROWN wire to DAC CN809
- 5.4 CN801 GRAY wire to DAC CN806
- 5.5 CN802 BROWN wire to DAC CN807

6, Remove J801/J802 jumper off

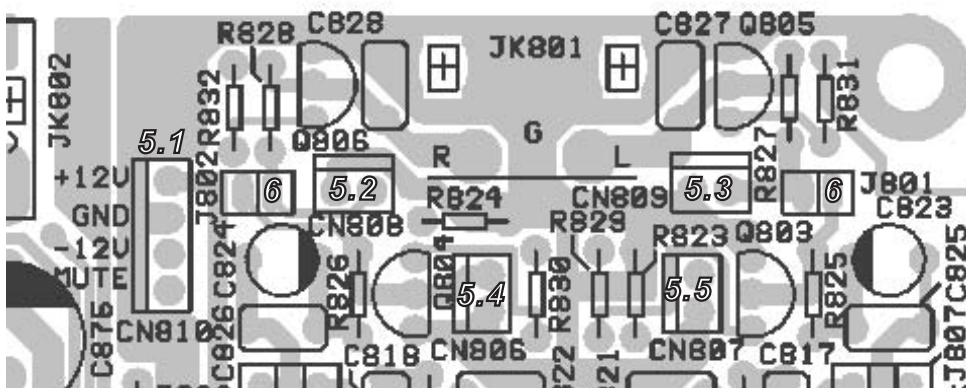

7. Dress parallel wire connecting DAC CN805 to CONTROL board as shown in photo. (If this wire is not dressed properly as indicated then unexpected noise may be generated.)

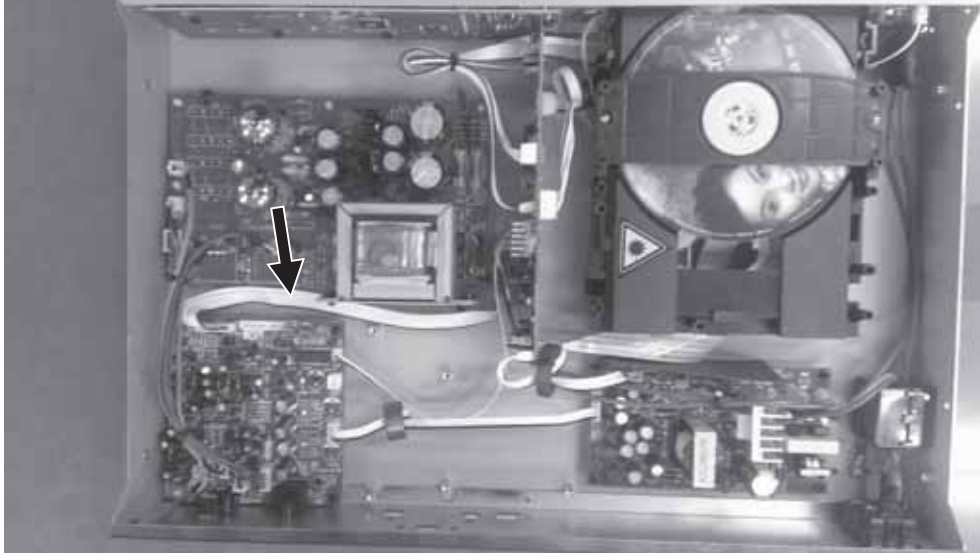

8. Tie cables properly

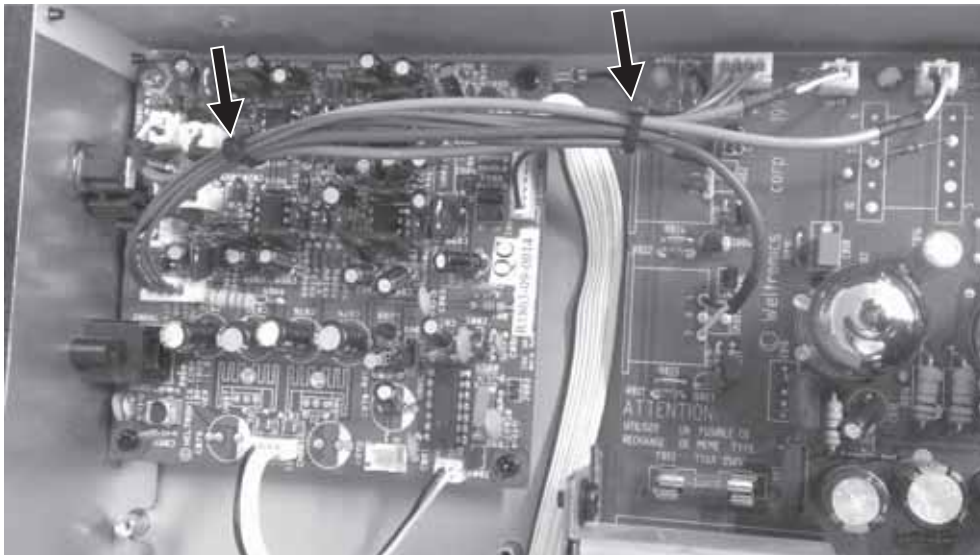

APPENDIX 4: Installing MD5502 into XCDis

Note:

1. R850 ~ R853 4 resistor in DAC Module were shorted must be changed to 220 ohm
2. MD5502 must be version MD5502c special modified for XCDie
3. USB module need to setup a USB driver in computer

MD5502 (90R-1869) series has 4 different versions ~
MD5502 – XCDic/XCDid
MD5502a - 3100MKII/3150MKII; XIA100/XIA150
MD5502b - US24192
MD5502c – XCDie
using the same PCBA module 90R-1869

1. MD5502 standard package

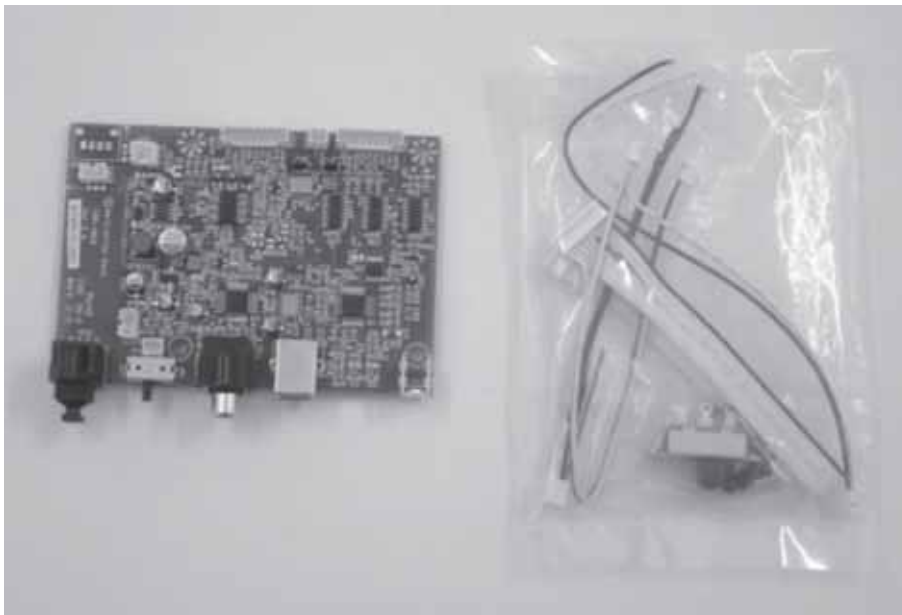



2. Screw positions

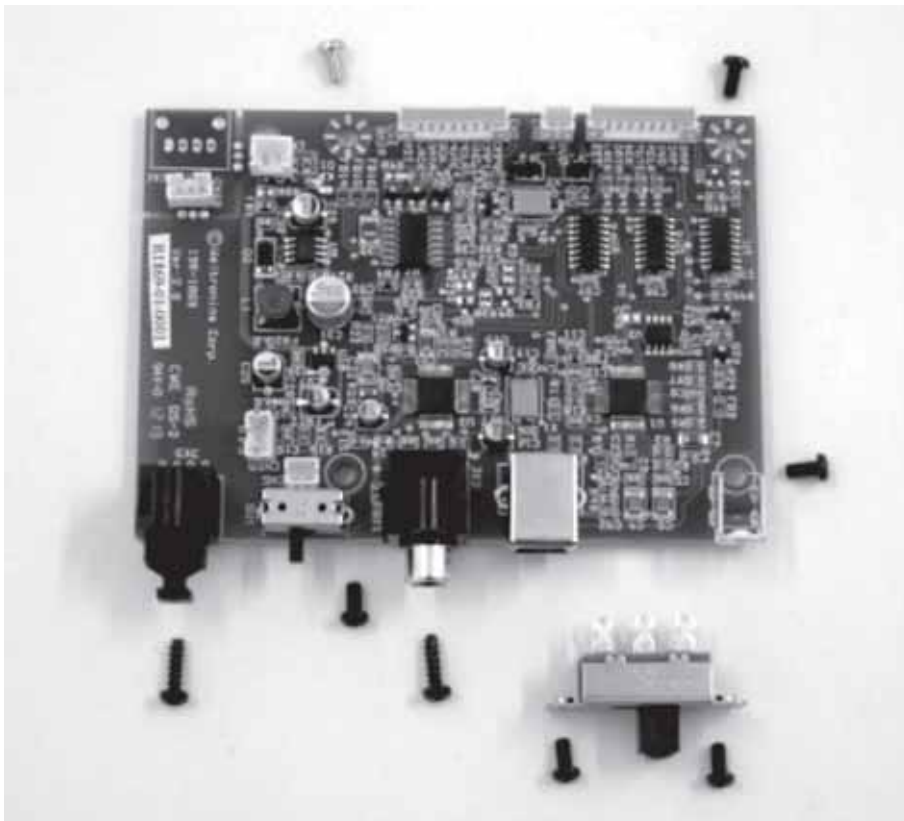

3. SW1 is only used in MD5502a for Integrated Amplifier XIA100/XIA150.

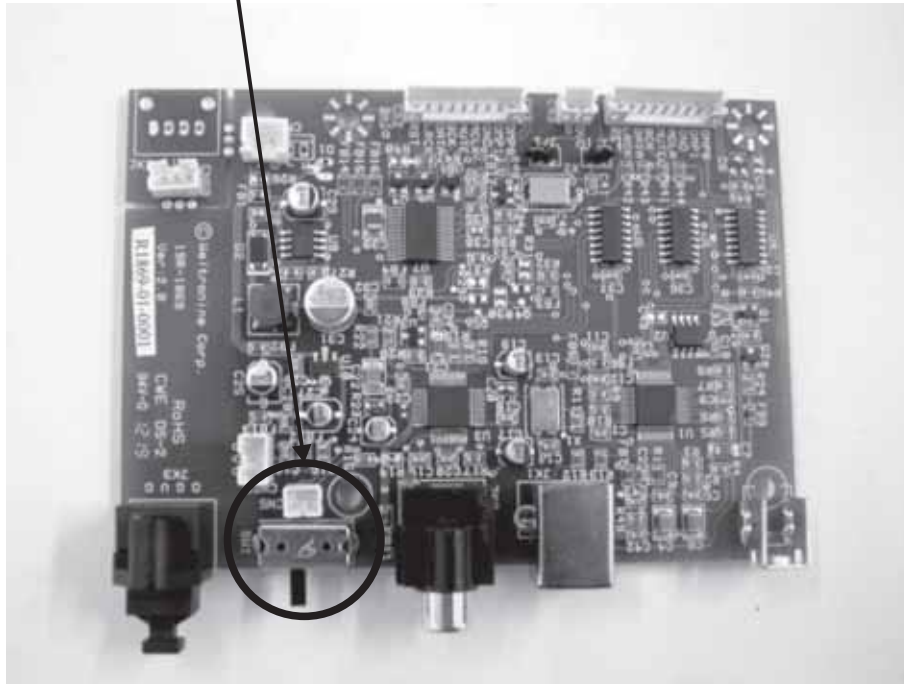

4. Screw MD5502c into XCDise chassis. (please refer screw positions pic.)

5. Pull off the 9 pins connector J12 in Control Module and re-connect it to CN2 USB MD5502c. (The connection is CN2 USB MD5502c (90R-1869) to CN805 DAC 90R-1863)

6. Insert the 9 pins connector packed in MD5502c to J12 Control Module and CN1 USB 90R-1869.

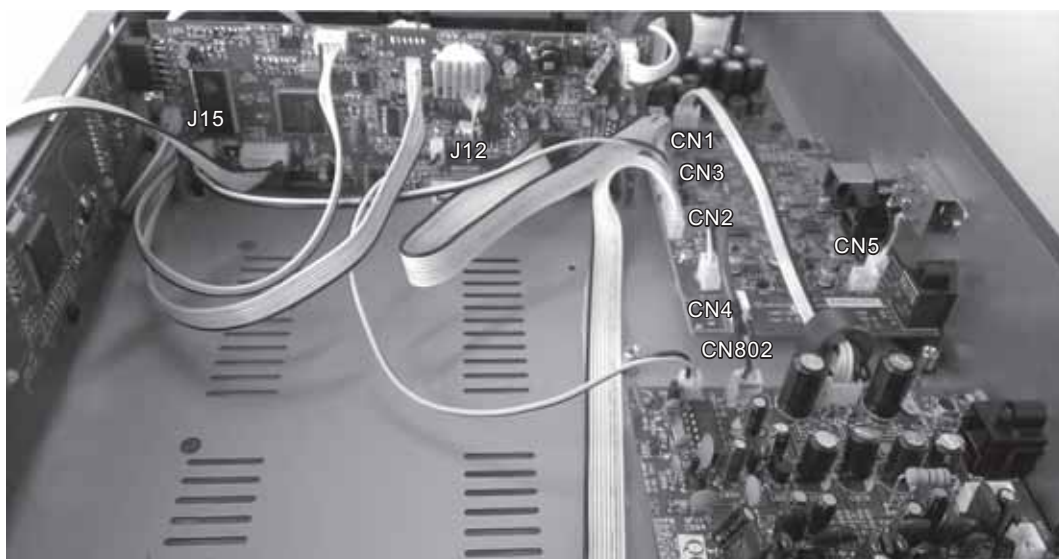

7. Insert the 2 pins connector packed in MD5502 to J15 of CD Control Module and CN3 USB MD5502c.
8. Insert 2 pins shielded wire packed in MD5502 to CN4 USB MD5502c and CN802 DAC 90R-1863 module.
9. Screw the slide switch packed in MD5502 to XCDie rear panel and insert CN5 connector.
10. Check Jumper setting
 - 10.1 DAC J801/802 jumpers are set to short; open jumpers when install MD5404 Tube Module.
 - 10.2 DAC J807/808 are set as shown in photo to have 5th order filter.
(J807/808 are set inside and with different R/C values can get 3th filter in the same PCB)

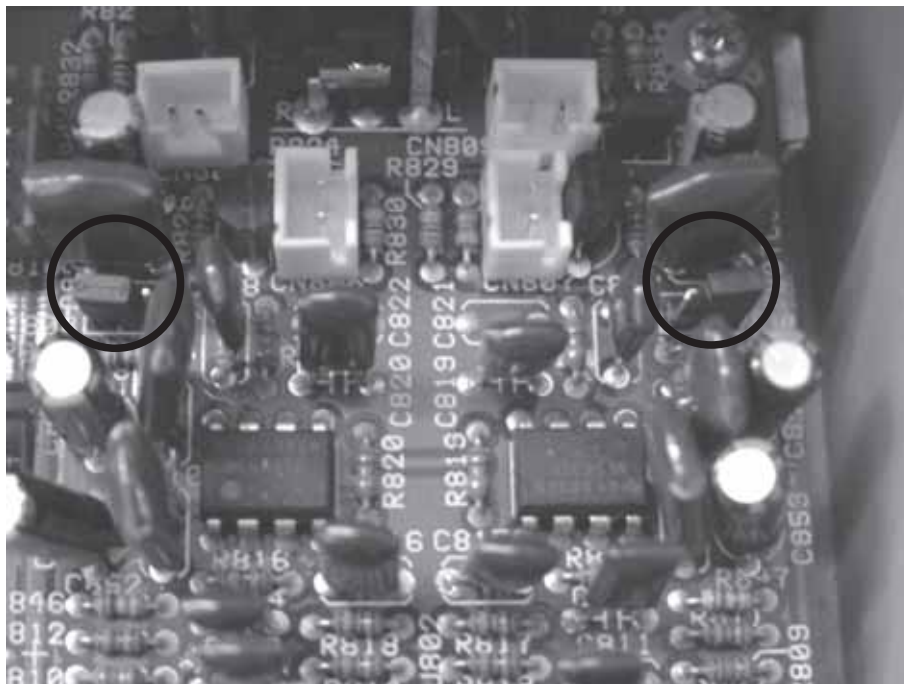

10.3 DAC J803, J804 & J809

Change jumper J803 – shorted -> Open; J809 open -> shorted (as shown in photo) to stop DAC clock. J804 is set to 5V.

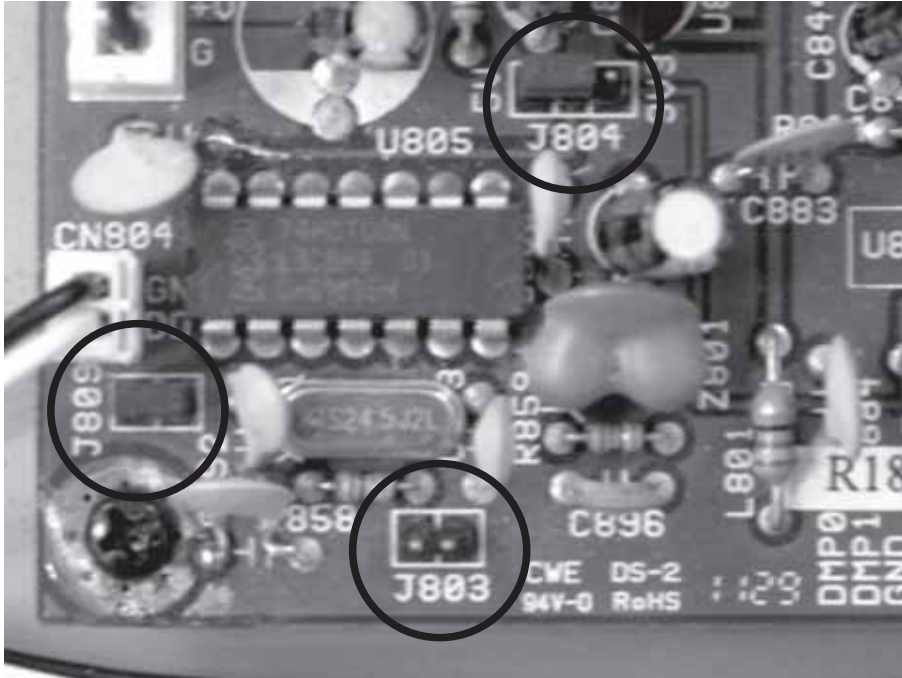

10.4 DAC J805 & J806 (J805 set to LOW)

Change Jumper J806 H-> L (as shown in photo) changing format from EIAJ to I2S.

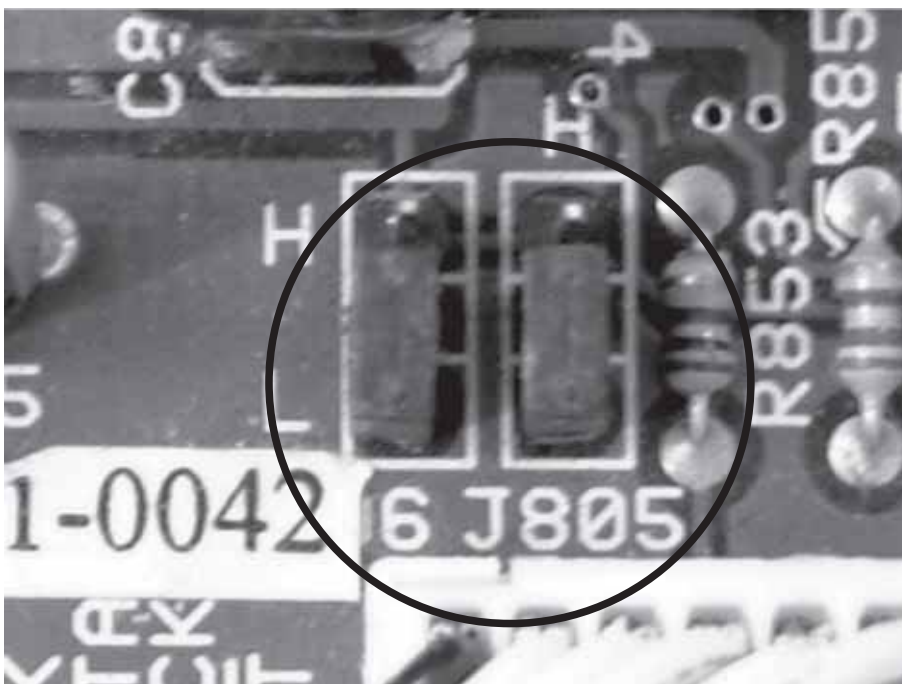

10.5 USB (MD5502 series) JP1 & JP2 (JP1 set to short)
JP2 is opened in MD5502/MD5502c and shorted in MD5502a/MD5502b.
Jumper JP2 to be opened or removed on MD5502/MD5502c board.

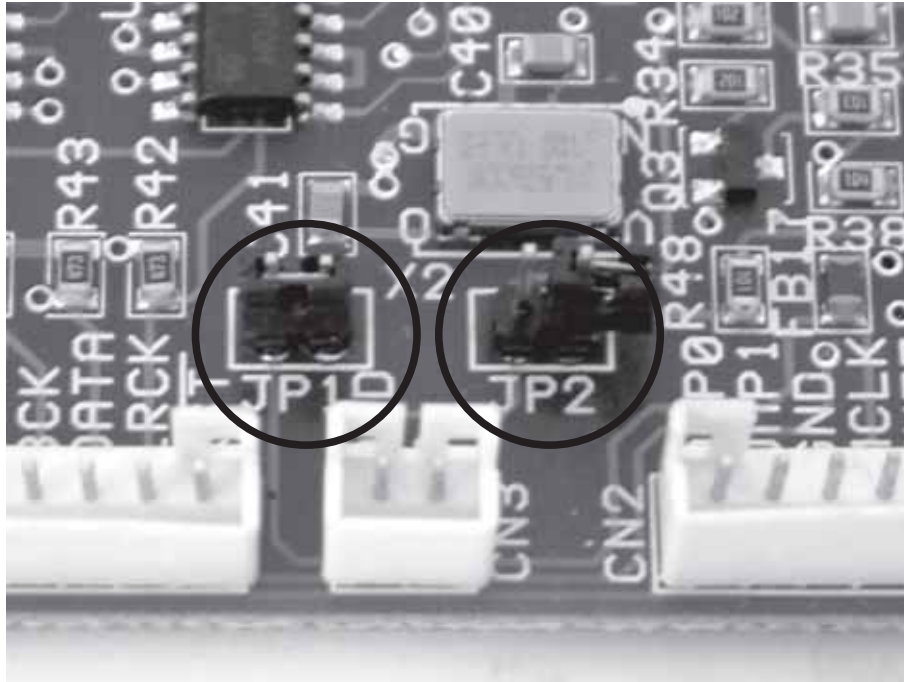

APPENDIX 5: RS-232 Protocol Specifications for XCDiS

Communication	RS232C UART / 9600bps / Data 8bit			
Version	Ver 1.0			
Baud rate	9600bps			
Command Format	CD Play	55_20_AA	"_" = blank space	
	Start	HEX	Descriptions	
			Stop	
Command	55	20	PLAY/PAUSE	AA
	55	21	STOP	AA
	55	22	1	AA
	55	23	2	AA
	55	24	3	AA
	55	25	4	AA
	55	26	5	AA
	55	27	6	AA
	55	28	7	AA
	55	29	8	AA
	55	2A	9	AA
	55	2B	0	AA
	55	2C	ENTER	AA
	55	2D	A-B	AA
	55	2E	PROGRAM	AA
	55	2F	CD/MP3/24192	AA
	55	F0	RANDOM	AA
	55	F1	TRK/TITLE	AA
	55	F2	TRK/TITLE<<	AA
	55	F3	TRK/TITLE>>	AA
	55	F4	SEARCH<<	AA
	55	F5	SEARCH>>	AA
	55	F6	CD	AA
	55	F7	USB	AA
	55	F8	SD	AA
	55	F9	24192	AA
	55	FA	PLAY	AA
	55	FB	PAUSE	AA
	55	FC	REPEAT	AA
	55	55		AA
55	FF	Read Status	AA	

Status Code	Status
21	CD PLAY
22	CD PAUSE
23	CD STOP
24	CD REPEAT
25	CD RANDOM
31	USB PLAY
32	USB PAUSE
33	USB STOP
34	USB REPEAT
35	USB RANDOM
41	SD PLAY
42	SD PAUSE
43	SD STOP
44	SD REPEAT
45	SD RANDOM
50	24192

APPENDIX 6: Control XCDIs through RS232 Using Computer

1. Equipment used:

- a. Computer PC
- b. USB to RS232 adaptor
- c. Software: CommUart Assistant Version 3.8 or newer
 - * Can be down load from Internet

2. Test Procedure

- a. CommUart Assistant Version 3.8 or newer
- b. Setting: Port : COM # you will use
 - Baud Rate : 9600
 - Dparity : None
 - DATA B : 8 bit
 - Stop B : 1 bit
 - Check : Show time stamp
 - Autoclear input
 - Send as Hex
- c. Test each RS232 command
 - Start code = 55
 - Stop code = AA
 - Command = Start code + Command Hex code + Stop code
 - *with space between each code
 - e.g.
 - Command Hex code of "Play / Pause" is "20"
 - Command of "Play / Pause" = 55 20 AA
 - (with Space between "55" & "20" and "20" & "AA")

SAFETY INSTRUCTION

1. READ INSTRUCTIONS

All the safety and operating instructions should be read before the appliance is operated.

2. RETAIN INSTRUCTIONS

The safety and operating instructions should be retained for future reference.

3. HEED WARNINGS

All warnings on the appliance and in the operating instructions should be adhered to.

4. FOLLOW INSTRUCTIONS

All operating and use instructions should be followed.

5. WATER AND MOISTURE

The appliance should not be used near water - for example, near a bathtub, washbowl, kitchen sink, laundry tub, in a wet basement, or near a swimming pool, etc.

6. CARTS AND STANDS

The appliance should be used only with a cart or stand that is recommended by the manufacturer.

6A. An appliance and cart combination should be moved with care. Quick stops, excessive force, and uneven surfaces may cause the appliance and cart combination to overturn.



7. WALL OR CEILING MOUNTING

This equipment is not designed for use mounted on a wall or a ceiling.

8. VENTILATION

The appliance should be situated so that its location or position does not interfere with its proper ventilation. For example, the appliance should not be situated on a bed, sofa, rug, or similar surface that may block the ventilation openings, or placed in a built-in installation, such as bookcase or cabinet that may impede the flow of air through the ventilation openings.

9. HEAT

The appliance should be situated away from heat sources such as radiators, heat registers, stoves, or other appliances (including amplifiers) that produce heat.

10. POWER SOURCES

The appliance should be connected to a power supply only of the type described in the operating instructions or as marked on the appliance.

11. POWER-CORD PROTECTION

Power-supply cords should be routed so that they are not likely to be walked on or pinched by items placed upon or against them, paying particular attention to cords at plugs, convenience receptacles, and the point where they exit from the appliance.

12. CLEANING

The appliance should be cleaned only as recommended by the manufacturer.

13. NON USE PERIODS

The power cord of the appliance should be unplugged from the outlet when left unused for a long period of time.

14. OBJECT AND LIQUID ENTRY

Care should be taken so that objects do not fall and liquids are not spilled into the enclosure through openings.

15. SERVICING

The user should not attempt to service the appliance beyond that described in the operating instructions. All other servicing should be referred to qualified service personnel.

16. DAMAGE REQUIRING SERVICE

The appliance should be serviced by qualified service personnel when:

- The power-supply cord or the plug has been damaged; or
- Objects have fallen, or liquid has been spilled into the appliance; or
- The appliance has been exposed to rain; or
- The appliance does not appear to operate normally or exhibits a marked change in performance; or
- The appliance has been dropped, or the enclosure is damaged.

17. POWER LINES

(APPLIES TO TUNER AND RECEIVERS ONLY)

An outdoor antenna should be located away from power lines.

18. OUTDOOR ANTENNA GROUNDING

(APPLIES TO TUNER AND RECEIVERS ONLY)

If an outside antenna is connected to the receiver, be sure the antenna system is grounded so as to provide some protection against voltage surges and built up static charges.

Section 810 of the National Electrical Code, ANSI/NFPA No. 70-1984, provides information with respect to proper grounding of the mast and supporting structure, grounding of the lead-in wire to an antenna discharge unit, size of grounding conductors, location of antenna-discharge unit, connection to grounding electrodes, and requirements for the grounding electrode. See Figure.

- Use No. 10 AWG (5.3 mm²) copper, No. 8 AWG (8.4 mm²) aluminum, No. 17 AWG (1.0 mm²) copper-clad steel or bronze wire, or larger, as a ground wire.
- Secure antenna lead-in and ground wires to house with stand-off insulators spaced from 4-6 feet (1.22-1.83 m) apart.
- Mount antenna discharge unit as close as possible to where lead-in enters house.
- Use jumper wire not smaller than No. 6 AWG (13.3 mm²) copper, or the equivalent, when a separate antenna-grounding electrode is used. See NEC Section 810-21(j).

Antenna Grounding According to the National Electrical Code

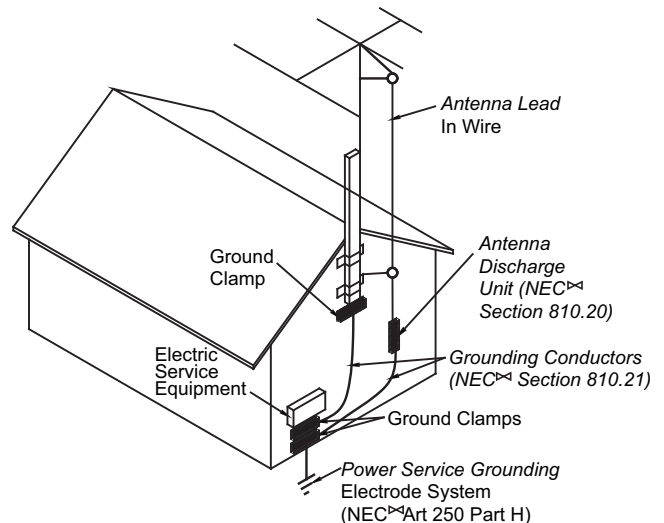

† National Electrical Code
Available from Library, book stores, or National Fire Protection Association (Batterymarch Park, Quincy, MA 02269).



WELTRONICS CORP.

LONDON/L.A.

AMC Web: <http://www.amchome.com>

PN: 21R-XCDise_v107