

ATOHM[®]



[GT SERIES]

TECHNICAL BOOK

The GT SERIES speaker range is the result of our passion and our desire to push experiences in home listening to the limits. It crowns our efforts to produce unique, easy to integrate products, which combine supreme quality performances and elegant lines.

Since the creation of ATOHM, our quest for perfection has led us to make very important technological investments. Our laboratory is equipped with the best research and development tools available: CA03D, dynamic simulations using the finite element approach, FFT analyzer, KLIPPEL measurements and vibratory analysis using laser interferometry are some of the tools we use in order to innovate, create and test our products. Our creativity is systematically validated by numerical simulations, several prototypes and advanced measurements. Finally, the objectivity of our scientific approach is mercilessly put to the test when confronted with subjective listening. Far from being extremely dogmatic, the development of our products involves continuous testing and listening to several technological solutions. We always give preference to the most pragmatic solutions and those which produce the best performances.

ATOHM's 'ABSOLUTE SERIES' loudspeakers, featured in the GT SERIES range, are the result of many years of research and endless tests. All of these loudspeaker components, as well as all of the acoustic speakers and their exclusive technologies were specially designed by our research department. It all comes together to form an indivisible whole whose sole and unique aim is to plunge the listener into the heart of the music and provide moments

Thierry COMTE

THE ATOHM SD28 ND04 RD “ABSOLUTE SERIES” TWEETER



This driver is a very high-performance direct radiating tweeter designed to cover a broad frequency range (2000 Hz to 30 kHz). It provides an ideal link up for the medium-high frequencies with low directivity. Its 28mm treated silk dome (1) produces sound which is soft, accurate and refined, without any undesirable coloration. In order to obtain a very high level of sensitivity **98dB/2.83V/1M** without having to opt for a horn and/or a compression chamber, we equipped this transducer with a powerful neodymium ring magnet (2).

This type of motorization was optimized using

the finite element method and assembled with the greatest precision and care, resulting in a flow of more than **17000 gauss** in the ferrofluid-filled air-gap. The upper part of the spectrum is therefore reproduced with exceptional dynamics and no thermal compression.

Furthermore, we have fitted the core with a **copper ring** to linearize and reduce inductance to the minimum (the higher the inductance value is, the weaker the response at high frequency levels is and the more intermodulation distortion becomes perceivable).

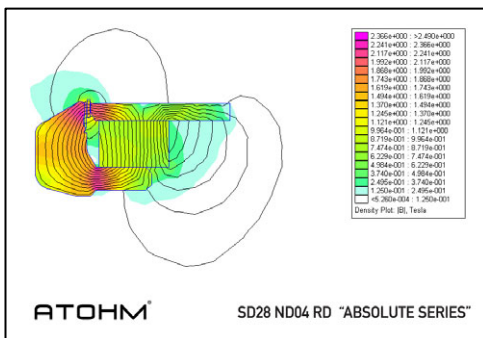
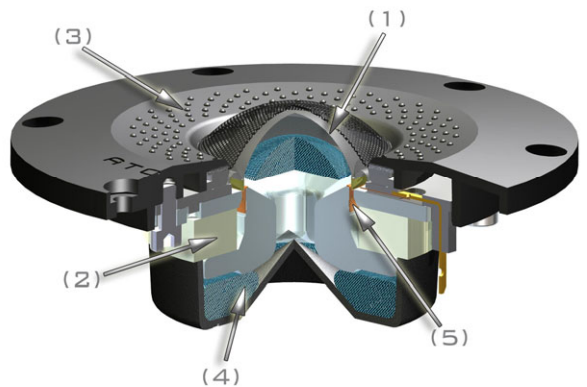

ELECTROMAGNETIC SIMULATION USING THE FINITE ELEMENT METHOD

The coil support is made out of aluminum (5) which ensures ideal conditions for transmission of the coil movement and the calories it generates. The coil is made out of **CCAW wire** (or Copper Clad Aluminum Wire), providing a combination of good conductivity and light weight. With the aim of reducing distortion (H2 and H3), we chose a configuration known as “**Inner hang**”. With this geometry, the winding length is shorter than the height of the air-gap. In addition, the moving coil is immersed in a perfectly constant magnetic flow whatever its position during excursions.

To provide a perfect mechanical base to the whole unit, the front panel (3) is made out of injected aluminum ensuring correct rigidity and elimination of interfering vibrations. This key part benefits from **ADP™** technology (Anamorphic Dispersion Patterns). This feature unique to ATOHM guarantees better off-axis dispersion and limits interfering reflections at very high frequencies. Finally, the **rear cavity** (4) optimizes the tweeter’s behavior at the lowest frequencies. The rear wave is first of all channeled through the core and then perfectly damped in the rear chamber.

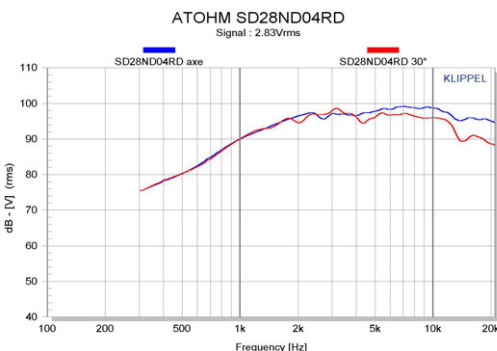

MEASUREMENT OF THE MAGNETIC FLOW USING A PRECISION GAUSSMETER

THE ATOHM "ABSOLUTE SERIES" WOOFERS



The diaphragm...

A great amount of study led us to understand that the properties of the diaphragm material do indeed have a great influence on frequency response. However, the overall result is very closely affected by factors such as the rigidity and length of the coil former, the mass of the winding, the nature and quantity of adhesive used for the former/diaphragm seal, as well as the geometry, mass and viscoelastic properties of the peripheral suspension. Perfect "piston" movement by the diaphragm only exists for a limited frequency range. The directivity of a perfect piston always remains proportional to the dimensions of its emissive surface (and not its rigidity). The different cone and suspension break-up modes increase or reduce the sound pressure according to their amplitudes and phases. Beyond certain frequencies, the coil support ceases to transmit the movement and is deformed due to combined action of the cone and the mass of the winding. This buckling also plays a part in reinforcing or cancelling the overall displacement of the cone (you could say that the support acts like a "spring"). The moving parts unit forms an "indivisible whole". As such, this "whole" needs to be optimized according to the goals to be achieved, without forgetting the absolute necessity of guaranteeing reliability and quality reproduction.

Our desire was to produce bass/midrange loudspeakers with a frequency response very close to the ideal, theoretically speaking, between 30 Hz and 4000 Hz. With these considerations in mind, we fitted our loudspeakers with a diaphragm made out of special alloy, aimed at expelling the audible break-ups out of this useful frequency range. Similarly, we combined it with a coil former made out of Kapton/Nomex so as to ensure perfect movement transmission in this nominal frequency range. In addition, this support with its adhesive seal, limits the transmission and absorbs part of the energy. These units have also been fitted with a peripheral suspension featuring a special profile which favors progressive break-up (LDST™ Technology) without noticeable hitches in the useful frequency range (typically between 700 Hz and 1800 Hz for the LD150).

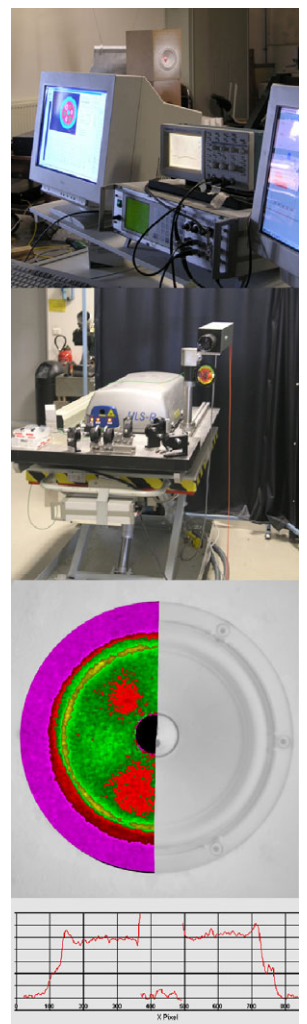

MEASUREMENT AND OBSERVATIONS VIA LASER INTERFEROMETRY, COURTESY OF THE APPLIED MECHANICS LABORATORY (FEMTO) IN BESANCON

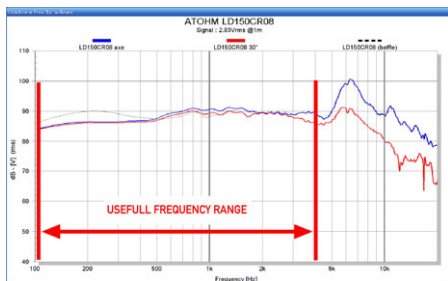

Drawing on simulations (finite element method) and measurements by laser interferometry, we optimized the numerous interactions and made precise adjustments to the geometry of the moving parts unit. The frequency response of our loudspeakers is characterized by exceptional linearity along the useful frequency range. Further along, the response is corrected using a specially adapted filter cell. By using rigid materials and perfectly stable adhesives, the performances are entirely reproducible from one unit to another maintaining a high degree of precision (which cannot be said for a paper diaphragm or one made from Kevlar®, for example).

our loudspeakers is characterized by exceptional linearity along the useful frequency range. Further along, the response is corrected using a specially adapted filter cell. By using rigid materials and perfectly stable adhesives, the performances are entirely reproducible from one unit to another maintaining a high degree of precision (which cannot be said for a paper diaphragm or one made from Kevlar®, for example).

OBSERVATION AT 1000Hz BY LASER INTERFEROMETRY

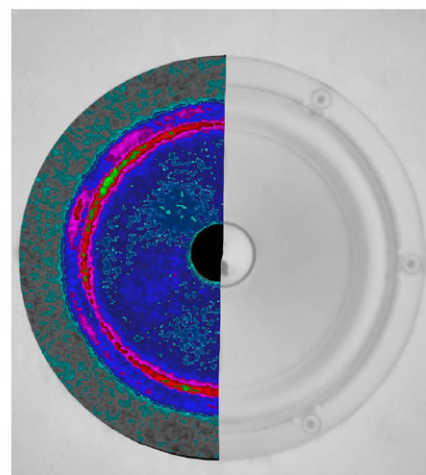

CONE MOVEMENT IS PERFECTLY UNIFORM (IN BLUE).

IN THE LOW FREQUENCY, ONLY PART OF THE SUSPENSION'S SURFACE IS EMISSIVE. AT 1000Hz, THE TOTAL SUSPENSION SURFACE IS EMISSIVE, (PROVOKING EXCESS AMPLITUDE IN THE FREQUENCY RESPONSE).

THE SPECIFIC PROFILE (LDS™ TECHNOLOGY) MAKES UP FOR THIS EXCESS AMPLITUDE BY IMPENDING PART OF THE SUSPENSION'S SURFACE (IN RED).

DIAPHRAGM BEAK-UP AT 1000Hz

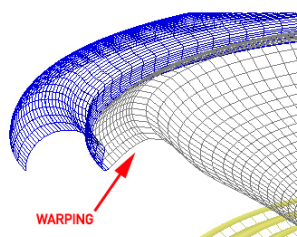

PAPER DIAPHRAGM

DIAPHRAGM BEAK-UP AT 1000Hz

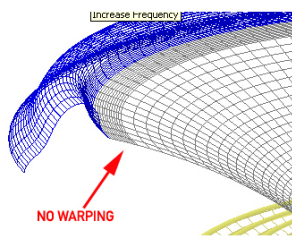

ATOHM LD150 DIAPHRAGM

Optimization of non-linearities ...

The absolute series of bass/midrange loudspeakers was the object of a great deal of research aimed at getting as close as possible to the ideal functioning parameters.

The loudspeaker is an electromechanical unit featuring a diaphragm which reproduces the musical signal by oscillating around its rest position (point 0). In absolute terms, the loudspeaker diaphragm must, therefore, oscillate perfectly symmetrically around this position. Its movement must be identical and proportional to the excitation signal. However, its elements (suspensions) and the electromechanical characteristics of the motor (force factor, inductance...) are subject to variations which change the "theoretical" movements of the diaphragm. These variations, also known as "non-linearities", have an effect on the excursions of the moving parts and create what is more commonly known as distortion. These are the factors which determine and limit the excursion capabilities of the moving parts.



Excursion measurements with a high precision laser sensor

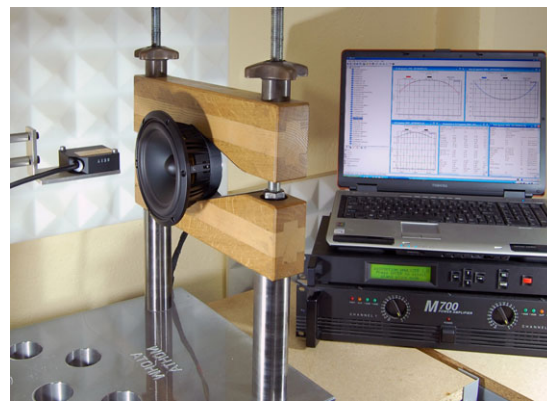

Measuring bench and KLIPPEL® non-linearity analyzing system

Based on the same postulate, particular care was spent on designing our transducers, using our powerful modeling tools in order to reduce all forms of distortion. The different parameters to be taken into account and optimized as far as possible were: the symmetry and the linearity of the stiffness coefficient of the suspensions (dynamic stiffness coefficient curve of the suspensions), the force factor resulting from the current running through the coil and the magnetic flow concentrated in the air-gap (dynamic force factor curve), as well as stability of the inductive value of the loudspeaker coil (dynamic inductance variation curve).

Based on the same postulate, particular care was spent on designing our transducers, using our powerful modeling tools in order to reduce all forms of distortion. The different parameters to be taken into account and optimized as far as possible were: the symmetry and the linearity of the stiffness coefficient of the suspensions (dynamic stiffness coefficient curve of the suspensions), the force factor resulting from the current running through the coil and the magnetic flow concentrated in the air-gap (dynamic force factor curve), as well as stability of the inductive value of the loudspeaker coil (dynamic inductance variation curve).

The Suspension and spider together ...

The loudspeaker diaphragm is held by its suspensions (peripheral suspension and spider). These suspensions act as a return spring. In absolute terms, the stiffness coefficient of this unit should be perfectly constant and symmetrical ($F = k \cdot X$). But in practice, the latter is neither linear nor symmetrical. The return force produced is therefore no longer directly proportional to the required displacement. In some ways, this prevents the diaphragm from placing itself in the precise theoretical position that the moving coil tries to force it into. **Reducing distortion, it is rendering the stiffness coefficient as linear and symmetrical as possible over a broad excursion range.**

As a result of detailed research and many experiments, the Atohm peripheral suspension and spider were optimized to obtain a stiffness coefficient which is noticeably constant and perfectly symmetrical. Their respective geometry and mechanical summation allow them broad excursion capabilities. Additionally, being designed with a specific profile (LDS™ technology), the suspension progressively breaks up in the midrange frequencies (between 700 and 1800 Hz). Finally, the materials which make up these units have been specially selected and offer the guarantee of top reliability as well as perfect stability over time.

As you can see on the curve on the right, the KLIPPEL® system maps the stiffness coefficient resulting from the sum of the peripheral and central suspensions (K_{ms}) according to the excursions of the moving parts (X). To the left of point 0, the excursion is negative, corresponding to the coil entering the motor and to the right of point 0, the excursion is positive, corresponding to the coil's exit from the motor.

The blue curve represents the measurements taken from a competitor's loudspeaker. You may notice that the asymmetric coefficient is very high... The minimal stiffness point is situated at about +2mm from the rest position. During its excursions, the diaphragm therefore tends "to go back to" this minimal point instead of oscillating freely around the position 0. The red curve represents the measurements for the LD150. It is almost symmetrical in terms of the stiffness coefficient, representing better mechanical power handling, improved dynamic capacities and reduced distortion.

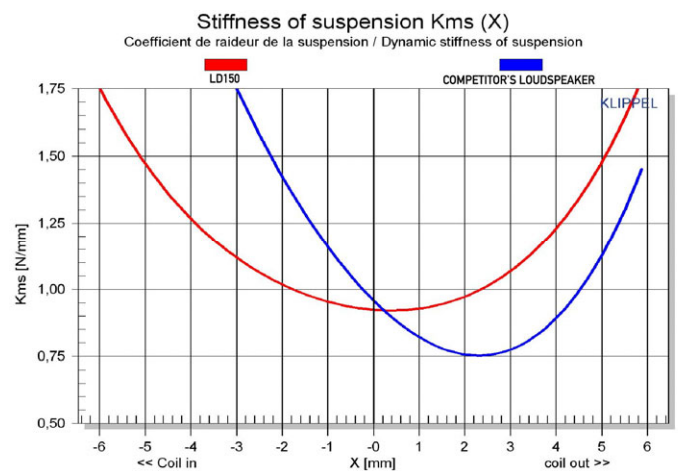

The motor : FWI™ Technology (Force Without Inductance) ...

The driving force applied to the diaphragm (BL) is the result of the electric current flowing through the moving coil and the magnetic flow produced by the magnet in the air-gap. In absolute terms, this flow should be constant whatever the coil's position. Now in practice, it is highly dependent on the geometry of the polar parts on the one hand, and on the other hand, it is modulated by the alternating current generated by the moving coil. Indeed, as a result of the current, the coil generates its own magnetic field. The latter does not contribute in any way to creating the driving force. This alternating magnetic field has an interfering effect and clearly disturbs the constant flux of the magnet. Alternatively, it increases or reduces the value of the constant flux in the air-gap. Moreover, this disturbance is proportional to the electric current flowing in the coil. **Reducing distortion, it is rendering the magnetic flow in the motor constant and symmetrical whatever the circumstances. It is also ensuring that the disturbance flux produced by the moving coil remains as weak as possible over a broad excursion range.**

Simultaneously, another parameter also disturbs correct coil displacement. By definition, when the coil moves, it is successively pushed towards the exterior of the motor and then towards the interior. The inductance of this coil is strictly related to the position with regard to the polar parts (ferromagnetic material), passing in turn from a low value to a high value. According to the rule of maximal flow, the moving coil is "attracted" towards the interior of the motor, where the inductance value is at its highest, in such a way that the (disturbing) flux that it generates is at its maximum (a current powered coil is always more attracted towards ferromagnetic material than towards air). The coil is therefore subjected to an additional force (known as magnetic reluctance force) which disturbs the driving force. This magnetic reluctance force is one-way (independent of the current direction) but remains proportional to the amplitude of the current flowing in the coil. Furthermore, the inductance variations lead directly to dynamic impedance variations. **Reducing distortion, it is rendering the inductive value of the winding as low, constant and symmetrical as possible over a broad excursion range.**

Optimized by the finite element method, the FWI™ technology motor has been designed in such a way as to produce a high force factor, which is perfectly symmetrical over a very broad excursion range. We equipped the motor with a powerful ferrite as well as polar parts designed to enable maximum magnetic flow. The flow density within the air-gap reaches 11000 gauss in the LD150 air-gap (height of 6mm) and 11600 gauss in the LD180 air-gap (height of 6mm). Coil interaction interferences have been taken into account in such a way that we obtain an inductance value which remains very low and constant whatever its position. To obtain this, we designed a rather special geometry for the core and for the copper ring which fits onto it. To satisfy the different electromagnetic factors, their proportions and dimensions were the object of a great deal of research using simulations and prototypes aimed at satisfying these electromagnetic criteria. Our aim was also to ensure optimal extraction of the heat generated by the moving coil and correct motor decompression.

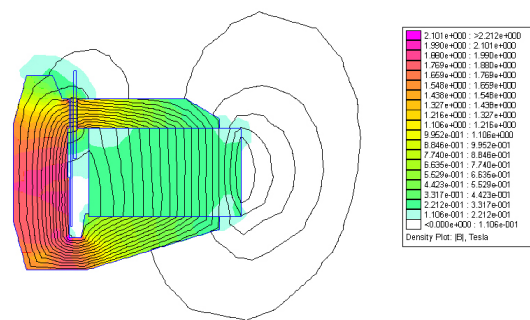

ATOHM®

LD 150 "ABSOLUTE SERIES"
MOTOR WITH FWI™ TECHNOLOGY

ELECTROMAGNETIC SIMULATION USING
THE FINITE ELEMENT METHOD

On the two curves here on the right, the KLIPPEL® system maps the force factor of the motor (BL) and the inductance value of the coil according to the excursion of the moving parts (X). To the left of point 0, the excursion is negative, corresponding to the coil entering the motor and to the right of point 0, the excursion is positive, corresponding to the coil's exit from the motor.

Force factor: The blue curve represents the measurements taken from a competitor's loudspeaker of similar size. You may note that there is a high level of asymmetry for this factor. It remains relatively constant when the coil exits the motor but it falls very rapidly when the latter re-enters the air-gap. Diaphragm movement is severely hindered on the negative half waves. When coil excursions are large then performances become very unstable. The winding tends to "slip away" from the central point and oscillates at the back of the motor (where the BL value is the lowest) instead of oscillating freely around the 0 position. The excursion and dynamic capabilities of this unit are very limited. Distortion appears even on short excursions. The red curve represents the measurements for the LD150. This curve presents a better leveling off as well as perfect symmetry. The excursion capabilities are better and the coil always oscillates around the reference point with no instability. The harmonic distortion level remains very low over a broad excursion range.

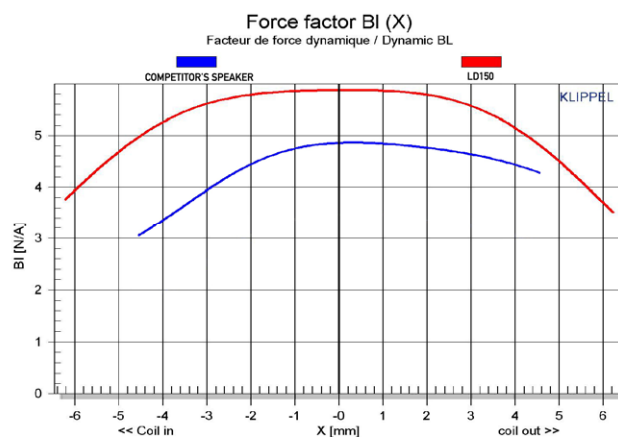

Inductance value of the winding:

The blue curve represents the measurements taken from the same loudspeaker as in the preceding test. It is worth noting that there is a high level of variation and the inductance value is totally asymmetric. The latter value is very high when the coil plunges into the motor and it is low when it exits. According to the current amplitude flowing through it, the coil is inevitably "attracted" towards the back of the motor (where the inductance value is the highest) instead of oscillating freely around the 0 position. The result of this phenomenon is the creation of third order harmonic distortion. In addition, this inductance variation leads to high dynamic impedance fluctuation (fluctuation of around 2 ohms at 1000 Hz when this 4 ohms loudspeaker operates at +/-4mm in the low frequencies). The result is high intermodulation distortion, in addition to the distortion due to "current flow" if the amplifier is not designed to handle such fluctuations. The red curve represents the measurement of the LD150. This graph shows the almost total inductive linearity of the moving coil (and therefore its perfect symmetry). The coil is therefore not "attracted" towards the back of the motor and oscillates freely around the 0 position. The third order harmonic distortion rate is drastically reduced. Furthermore, with the variation being almost nonexistent, the dynamic impedance of this unit remains perfectly stable. Intermodulation distortion is therefore very low and the amplifier can perform in much better conditions.

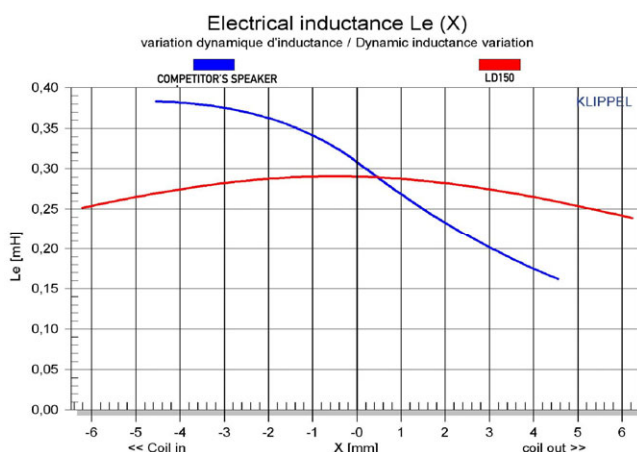

The frame...

ATOHM's « Absolute Series » loudspeakers are equipped with exclusive frames. Designed and developed by our research department, they are made out of injected aluminum. Their shapes were designed according to their functions and we took into account several parameters during this design stage. We determined the main functional dimensions according to the pre-set requirements such as: the depth of the diaphragm, its excursion range (respective diameters of the suspension and the spider / height of the required base planes) and the requirements for integration of the motor. We then integrated the different mechanical, acoustic and aesthetic constraints, which also had to be taken into account as part of the creative process.

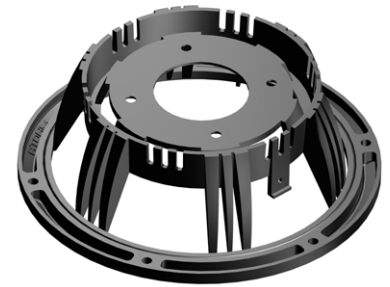

The ATOHM's frame is extremely rigid, providing the perfect mechanical support to the loudspeaker unit as a whole. Thanks to its thick, ribbed crown shape, the loudspeaker is attached firmly to the cabinet. Altogether it has 18 fine spokes which play an excellent role in optimizing rear wave flow. The rear volume of the spider features tiny openings which provide adequate ventilation, and also limit the possibility of potentially harmful particles entering the volume. The motor is fixed solidly to the frame along a wide base plane using screws and special adhesive. Finally, due to its material composition and the large surface area, the basket plays an active role in cooling the loudspeaker by evacuating the calories accumulated within the motor.

ATOHM LD150 (GT1 AND GT2)

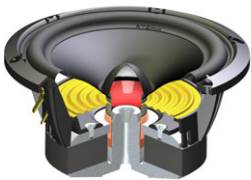

This 6 inches diameter driver unit is used in the GT1 bookshelf speakers as well in the GT2 column speakers and covers the entire bass midrange spectrum (20 Hz-2500 Hz). The combination of the characteristics described above (the suspension geometry, diaphragm type and FWI technology) enable it to reproduce the

entire bass register as well as the upper midrange with great ease. The rate of distortion is very low, whatever the volume level.

It features a copper coil measuring 25mm in diameter (15 mm coil length / Kapton-Nomex base), bathed in a static flux of 11000 gauss (6mm air-gap , 100mm ferrite). The 4 ohm version featured in the GT1 has a sensitivity level of 91dB/2.83V/1 and the sensitivity of the 8 ohm version in the GT2 is 89dB/2.83V/1m.



ATOHM ML150 (GT3)

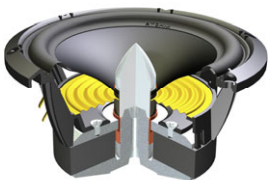

This 6 inch is a direct product of the LD150 development. It includes a majority of its components (special alloy diaphragm, suspensions, FWI motor technology...). However, we optimized the MLD150 in order to integrate the GT3 midrange channel and to cover a broad frequency range (180 to 2500 Hz). This unit is thus equipped with a machined aluminum phase plug. Its special shape increases the directivity of the loudspeaker and improves motor cooling. Furthermore, as there is no dust cap,

the moving parts are lighter (by about 5%). In addition, the coil length in this case is reduced to 10mm. This allows sensitivity to reach a level of 94dB/2.83V/1m (!!), and current requirements and thermal compression are reduced.

Sound reproduction is precise, refined and very dynamic over a wide frequency range



ATOHM LD180 (GT3)

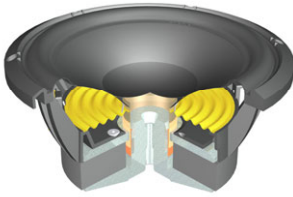

This 7 inches diameter driver unit is used in the GT3 column speakers to reproduce the bass register (20Hz-180Hz). Thanks to its motorization (FWI technology) and its suspensions, it is capable of linear excursions of +/- 8mm (+/- 11mm max peak)! It is equipped with a copper coil measuring 35mm in diameter (coil length 22mm / support Kapton-Nomex), bathed in a static flux de 11500 gauss (air-gap 6mm, 120mm ferrite). Its sensitivity is 91dB/2.83V/1m (2PI radiation). The base of the cone (made of special alloy) features 8 holes to maximize decompression of the core and coil cooling and at the same time minimize flow noise. Its excellent power handling (thermal and mechanical) enable it to reach the highest sound levels with very low levels of distortion.



[FILTERING AND AJUSTABLE FREQUENCY RESPONSE]

TCC™ Technology...

Profiting from the experience acquired when developing our previous loudspeaker models, plus the intensive listening sessions, our filtering technology TCC™ (Time Coherent Crossover) provides an ideal link between the midrange source and the tweeter, for such criteria as phase, group delay and impulse response.

The midrange loudspeaker (or bass/midrange) and the tweeter are positioned on the same vertical plane (single baffle). Due to their respective geometry (notably that of the depth and the vertical position of the moving coils), these two transducers do not share identical time origin. In more practical terms, when the listener is facing the speakers, the midrange loudspeakers "start" later than the tweeters. Conventional filters allow you to adjust the phase so as to ensure linear frequency response. However, they do not provide a remedy for the initial cause (the time delay) and only increase the group delay at the transducers' roll-off frequency. Another solution consists of slightly changing the position of the tweeter compared to the midrange loudspeaker, by adjusting the alignment on the baffle. Nevertheless, part of the sound signals emitted by the tweeter's transducer is reflected by the non-alignment of the baffle (at a more or less sharp angle). This results in irregular frequency response, which is confirmed by a lack of sound stage precision.

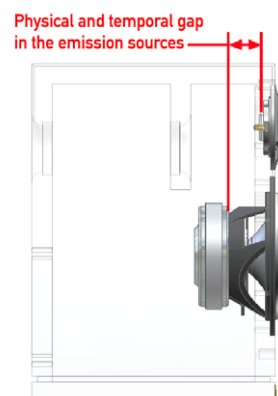

To solve this problem, ATOHM filters include temporal calibration cells (delay line) for the treble range. Apart from this first advantage, using these calibration cells makes it possible to use 1st order filters (6dB/oct). This type of structure limits phase rotation at the roll-off frequency and also reduces group delay. In other words, ATOHM filters adopt "gentle slopes". Specific cells are added to correct some of the physical phenomena which occur, such as motional impedance compensation, impedance compensation, parallel notch filter etc...

When listening, the TCC™ Technology results in a realistic and perfectly "holophonic" sound stage being reproduced. The notion of sound layers is perfectly respected; with amazing ease, the instruments take up their positions on the stage. What is also very characteristic is the perfect "fusion" between the different transducers.

As far as components are concerned, they are carefully calibrated and must fulfill a certain number of precise quality requirements. Some of these components include: air core inductors, low resistance iron core inductors, MPT capacitors, metal oxide resistors etc...

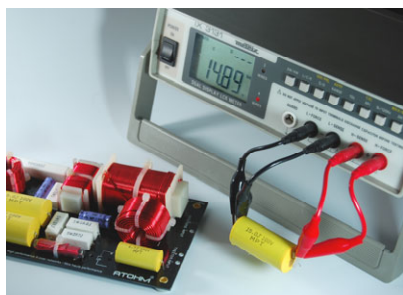
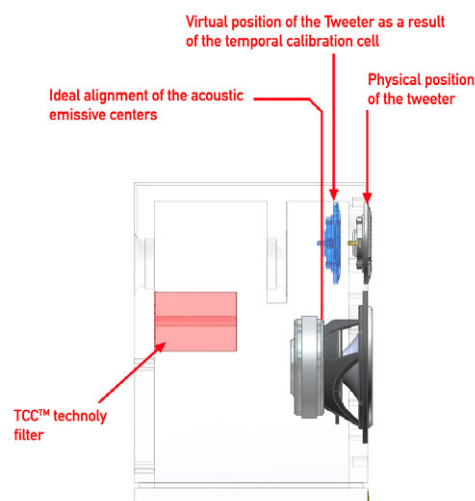

Attached firmly to a very thick aluminum plate, our special terminal binding posts accept heavy gauge wire, forks and banana plugs. To remain coherent, speakers in the GT range are delivered with standard "mono-wiring". However, for those passive bi-amplification enthusiasts, the speakers can also be delivered in bi-wired version (optional).

Adjustable frequency response...

The frequency response, directivity, distortion and the baffle geometry are some of the parameters which make up "the sound identity" of an acoustic loudspeaker. The "objective" parameters are totally quantifiable when creating a product, and are, in principle, totally reproducible. However, the speakers are designed to fit into an acoustic home environment. This environment according to its architecture, proportions, reverberation as well as the way it is set out and furnished, has its very own individual sound "signature". Clear, reflecting, or absorbent, this identity varies significantly from one environment to another. The listening performances are a direct result of the combination of the speakers and the room. To a lesser extent, the amplifier also has its own sound signature which also affects the overall result. Ideally, the speaker response should be specially adjusted to each room and to each configuration.

In order to improve coupling between the listening room and the amplifier, we have fitted speakers in the GT range with response adjustment switches. These switches have three positions and functions. As opposed to corrective measures proposed on some amplifiers, the modification carried out by this switch is done on a "plateau" over a wide frequency range and not on one frequency only. According to the characteristics of the listening room and the amplification used, it is possible for the listener to choose between "smooth", "linear", or "high definition" listening.

GT1 and GT2 frequency response adjustments

This three position switch operates on the frequency bands between 2500 and 30 kHz with intervals of 2 and 3dB; or a maximum modification of 5dB in amplitude.

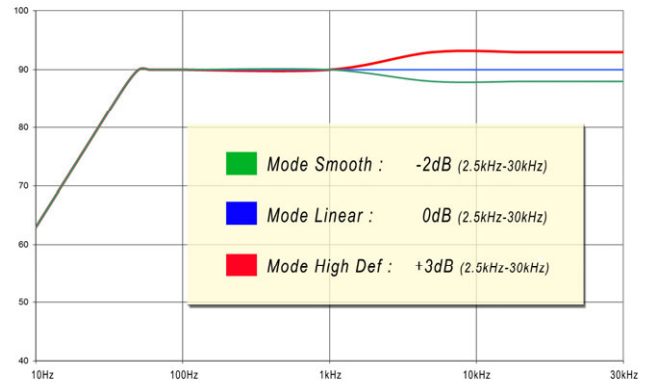

GT3 frequency response adjustments

The GT3 column speaker features two switches with three positions: the first switch is for frequencies ranging between 500 Hz and 2.5 kHz, and the second one is for frequencies between 2.5 kHz and 30 kHz with intervals of 2 and 3dB, or a maximum of 5dB amplitude adjustment. In total, the GT3 can offer 9 different frequency responses.

TWEETER ADJUST



MIDRANGE ADJUST

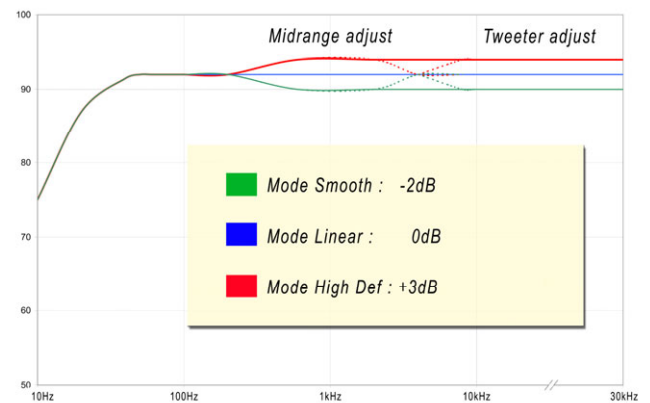

[THE LOAD, THE CABINET, THE GRILLES...]

ACOUSTIC LOAD...

ATOHM speakers use a bass-reflex type enclosure. The tuning frequencies as well as the vent section were very finely adjusted to obtain maximum performances in the bass register (distortion, frequency response, excursions of the moving parts and air flow noise).

On the GT2 and GT3, response in the bass frequencies can be adjusted by inserting into the stand a plug made out of open-cell foam (supplied). According to the characteristics of the listening room and the positioning of the speakers, these plugs offer the possibility of adjusting bass frequency reproduction (these plugs are particularly efficient when the speakers are placed too close to the rear wall and/or corners).

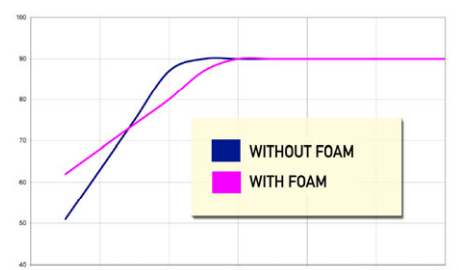

HOW THE REAR WAVE IS TREATED...

Damping of the rear wave is done by completely lining the interior of the cabinet panels with recycled cotton fiber and placing polyester fabric in pre-defined positions. Final dosage of the materials was carried out by taking measurements of the near field and the impedance in order to eliminate residual standing waves without over-damping or making detrimental modifications to the loudspeaker's electromechanical parameters.

[GT2 and GT3] :

Conventional "column" speakers have a bigger rear volume than smaller "book shelf" type speakers. This large internal volume is exposed to reverberation (standing waves) due to sound reflections between the cabinet panels. The most harmful of these mount up vertically between the top and bottom edges of the speaker cabinet. Indeed, the cabinet cross-section being thin, the reflection rate between the base and the top of the cabinet is high. In simple terms, the speaker can be described as a simple vertical "tube" which is closed off at both ends. Inclining the concerned panels or eliminating any parallelism does not fundamentally change this behavior. Adding a thick, absorbent fabric lining limits this phenomenon. However, with it not being very selective, it can also lead to over damping the whole of the medium bass register and modifying the behavior of the loudspeakers in the lower spectrum. The first resonance frequency is proportional to the height of the speaker (1 half wave length). As far as amplitude in this mode is concerned, it is affected by the position of the bass loudspeaker(s) and by the quantity of damping material lining the interior of the cabinet.

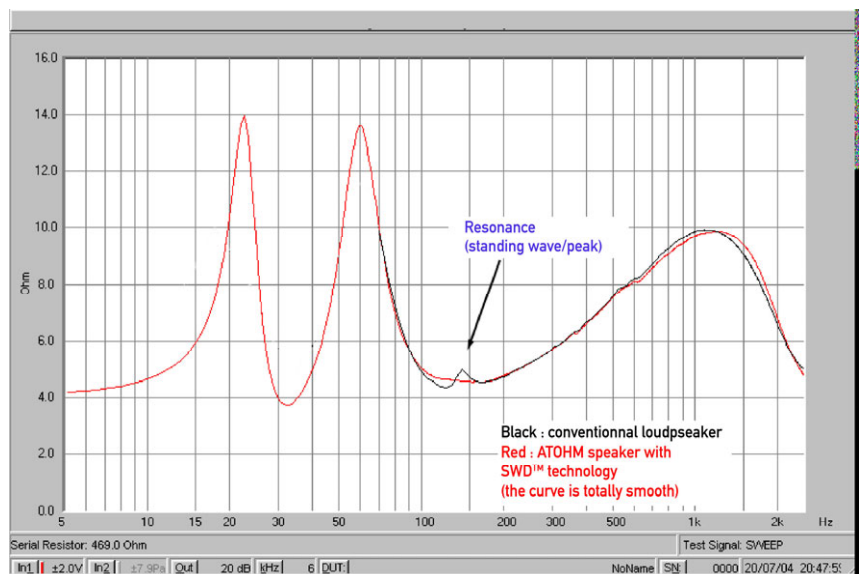

This accident is often revealed on the impedance curve (slight peak situated between 100 and 200 Hz) or by using a near field pressure measurement. When listening, this produces an upper-bass register which is somewhat "puffy" and certain musical notes linger on (known as smearing).

To solve this problem, ATOHM "column" speakers feature SWD™ Technology (Standing Wave Damper). This specificity is characterized by the addition of a laminar damping compartment located in the base or in the top part of the speaker. This compartment consists of a choke (acoustic impedance-matching transformer /acoustic filter) and a volume filled with perfectly dosed damping material. Thus, by channeling and damping the rear wave, this system cancels out the main reverberation built up in the rear volume.

When listening, the SWD™ technology is characterized by a crystal-clear upper-bass/lower-midrange register with no coloration and with perfect undertones.

SWD™ TECHNOLOGY (Standing Wave Damper)

The standing wave are trapped and then damped. They cannot re-enter in the principal volume and hinder the functioning of the loudspeaker.

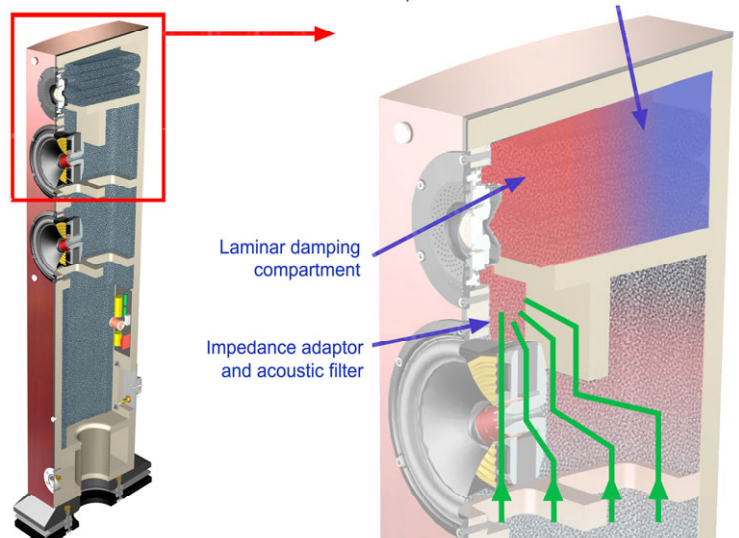

[GT3 only] :

The MLD150 midrange unit is loaded in a volume which is totally sealed off. As it is totally isolated from the speaker's internal volume, it is not disturbed by the excursions of the two LD180 subwoofers. This cavity functions using the PRD™ technology (Progressive Rear Damping). The cone shape of the rear profile is lined with damping material which is increasingly compressed with the depth. The rear wave of the loudspeaker is gradually damped and its return towards the diaphragm is noticeably reduced.

The combination of the special shape of the load, the damping material and the small size of this cavity, quite simply prevents the formation of any standing waves!

When listening, the combination of the exceptional characteristics of the MLD150 and the PRD™ technology produces a very precise midrange, particularly audible on transitories. There is no coloration due to the enclosure and harmony with the other drivers units channels is perfect.

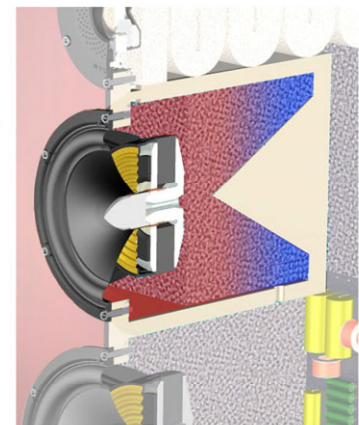
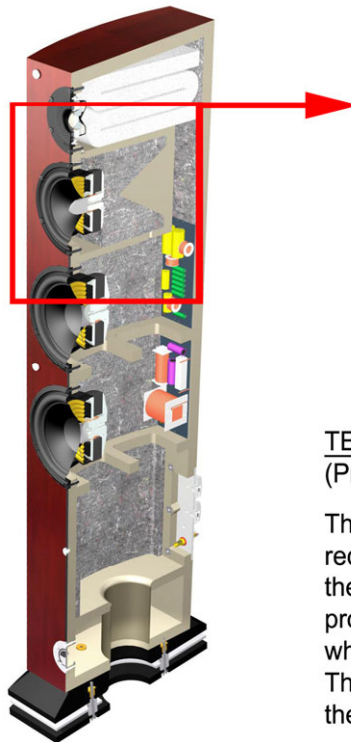

TECHNOLOGIE PRD™
(Progressive Rear Damping)

The cone-shaped geometry provides reduction of the cross section the deeper the wave goes. The rear wave is treated progressively by the damping material which is more and more compressed. The wave does not reflect back towards the driver unit.

THE SAND COMPARTMENT AND PDS™ DECOUPLING (for GT2 and GT3 only)

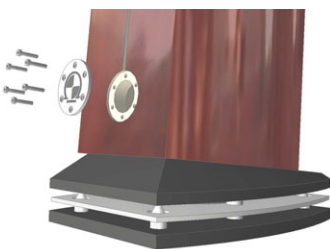

The GT2 and GT3 column speakers feature a special compartment at its base designed to enable sand filling (the sand is not supplied). To fill the compartment with sand (about 3L / 5 Kg for GT2 and 4L / 7kg for GT3), remove the logo plate, which also serves as an elegant cover to protect the opening. Once you have filled it with fine, dry sand this compartment will help to stabilize the speaker and damp any interfering vibration from the cabinet.

PDS™ decoupling (Progressive Damped Spiking) provides progressive decoupling of the speaker. The vibrations are first channeled onto the lower plinth using braces. This lower plinth features four "master" cones made out of machined aluminum. The "secondary" cones are directly screwed to the back of these "master" cones and are put into contact with the floor. Due to the weight of the speaker, the lower plinth is put under pressure and the four "master" cones make contact with the upper plinth. As a result of this particular feature, the residual vibratory energy is directed towards the upper plinth, which absorbs the disturbance. Only a tiny amount of vibration is therefore transmitted to the floor via the "secondary" cones.



DIAGRAMM AND DESCRIPTION OF HOW THE PDS™ DECOUPLING SYSTEM WORKS

By including this exclusive decoupling system at its base, the GT2 and GT3 are guaranteed perfect stability. Transitory effects and "attacks" are reproduced with perfect clarity.

THE CABINET

The cabinets for ATOHM's GT SERIES speakers are all made out of high quality MDF. The curved side panels are obtained by gluing together several thin 3mm layers of wood, which are shaped in a special mould and held firmly together until the glue is completely dry. They are then machined using high precision computer numerical controlled machine tool before being fixed to the other elements of the cabinet. Internal reinforcements are fixed in strategic positions (measured by a laser vibrometer) in order to limit interfering vibrations. Three different finishes are available: black piano, white piano, rosewood piano veneer. Once they have been veneered, the cabinets are varnished for a lacquered piano type finish. The cabinets are polished to obtain perfect transparency and shine.

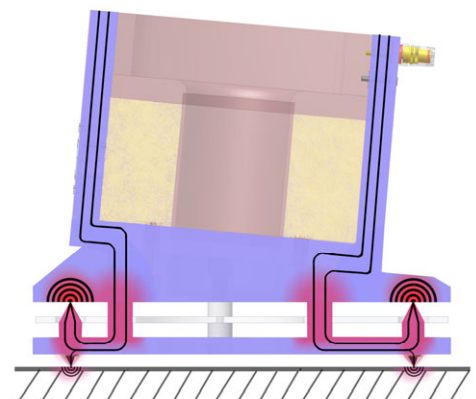

MEASUREMENTS BY LASER VIBROMETER

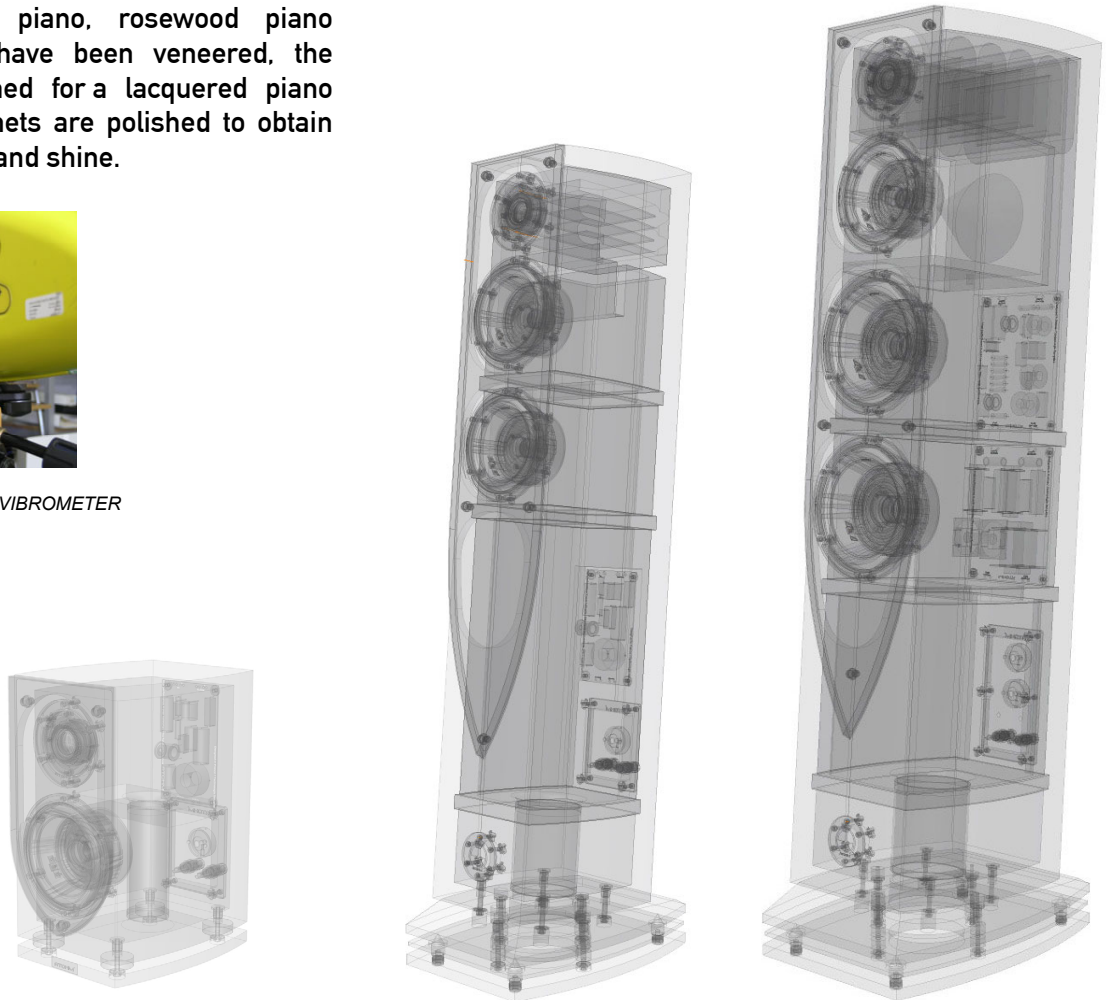

THE GRILLES

Speakers in the GT range are supplied with two types of grille. The first type consists of an MDF frame around which fabric is stretched. This frame is fixed onto the speaker using neodymium magnets. This first type of grille is generally considered as being the most classic in style.

The second type of grille is made out of metal, is round in shape and is also covered by fabric. This grille is fixed directly onto the bass/midrange loudspeaker frame. With this type of fixture, the speakers have a more "trendy" look about them. Furthermore, this solution also has the advantage of preserving the quality of the listening performances while at the same time offering good protection to the diaphragm. Note that the tweeter is also permanently equipped with a metallic protection grille.



ASSEMBLY AND QUALITY CONTROL

ATOHM speakers are meticulously assembled in France, in the city of PIN. Before leaving our factory, they undergo a certain number of quality checks. They are passed onto the measuring bench to check frequency amplitude response, impedance and distortion, as well as undergoing a sweep test. These stringent tests enable us to deliver two speakers paired to approx. +/-0.8 dB.



[TECHNICAL SPECIFICATIONS]

| | [GT1-HD] | [GT2-HD] | [GT3-HD] |
|---------------------------|--------------------------------------|--|--|
| Type | Bookshelf speaker 2 ways bass reflex | Floorstanding speaker 2+1 ways bass reflex | Floorstanding speaker 3+1 ways bass reflex |
| Power handling | 100 Wrms | 200 Wrms | 300 Wrms |
| Peak power (400ms) | 200 W | 400 W | 800 W |
| Impedance | 6 Ohms | 6 Ohms | 6 Ohms |
| Sensitivity (2.83V/1m) | 89 dB | 90 dB | 92 dB |
| Frequency response (-3dB) | 45Hz-30kHz | 40Hz-30kHz | 35Hz-30kHz |
| Bass Midrange Driver | LD150 CR 04 | LD150 CR 08 (*2) | LD180 CR 08 (*2) / MLD150 CR 04 (*1) |
| Tweeter | SD28 ND 04RD | SD28 ND 04RD | SD28 ND 04RD |
| Dimensions (H*W*D) | 330*200*265 (mm) / 13*8*10.5 (inch) | 1085*200*265 (mm) / 42.7*8*10.5 (inch) | 1190*240*435 (mm) / 47*9.5*17 (inch) |
| Weight | 12 Kg / 27lbs | 26 Kg (without sand compartment) / 58lbs | 37.5 Kg (without sand compartment) / 83lbs |

Our products and packaging materials are in compliance with the strictest environmental legislation (RoHS norms). We make the necessary steps to ensure that our all suppliers deliver components that contain no trace of heavy metals or illegal substances. The damping materials that we use inside our cabinets contain no particles considered as toxic for your health or that of your family and friends (which is not the case for certain types of felt made of fiber glass).

ATOHM®

12 Rue du Breuil

70150 PIN (France)

phone : +33 3 81 47 91 01

e-mail : contact@atohm.com Internet: www.atohm.com

DESIGN BY THIERRY COMTE

ATOHM® / WELCOHM TECHNOLOGY (France) / All reproduction right reserved